

COMPANY PROFILE

MADO
LIGHT



- About Us
- Lighting Designer Department
- Manufacturing of Decorative Poles
- Our Design
- European & Global Brands
 - INTERIOR Products Categories
 - EXTERIOR Products Categories
- ISO 9001:2015
- SASO Certificates
- Projects References & Consultants Approval
- Gallery
- Organization Chart
- Registration Certificates

ABOUT US

Herafion Lighting is a leading company considered as one of the national companies specialized in the manufacture of lighting poles. Herafion was Established in 2009 and it's based in Jeddah - KSA. herafion Lighting has successfully completed numerous large-scale turnkey projects for many prestigious clients in different sectors including:

1. Lighting poles for highways and main roads.
2. Lighting poles for Gardens in different regions in the Kingdom.
3. Hazardous Lighting for oil, gas and petrochemical industries.
4. Copper lanterns and chandeliers for mosque and palace.
5. Commercial Lightings for Palace, Villas, offices, Hotels, Towers, Mall...

Mission

Herafion is committed to provide the highest quality product possible through our highly skilled and dedicated employees and state-of-the-art and manufacturing process. Proper employees are expected to serve the customer with the highest level of technical knowledge in the industry. That result in customer and employee satisfaction.

Vision

We aim to be the country's leader in providing indoor and outdoor lightings and related services and make lighting more effective, efficient, cost-effective, and enviro-friendly.

Herafion has positioned itself as a market leader in the Kingdom for the design and distribution of architectural, industrial and commercial lighting solutions. It distributes a diverse range of light fittings to the industrial and wholesale markets.

The following is an overview of our products and company divisions :

LIGHTING DESIGNER DEPARTMENT

In this section, a group of engineers and designers are specialized to carry out studies and required maps for the implementation of interior and exterior lighting projects for factories - Oil & Gas Plant - offices - hospitals - schools - universities - Malls - government departments - stadiums - tunnels etc ...

Our Lighting engineers help you to design Dialux Lights Simulations & LED lighting FOR FREE

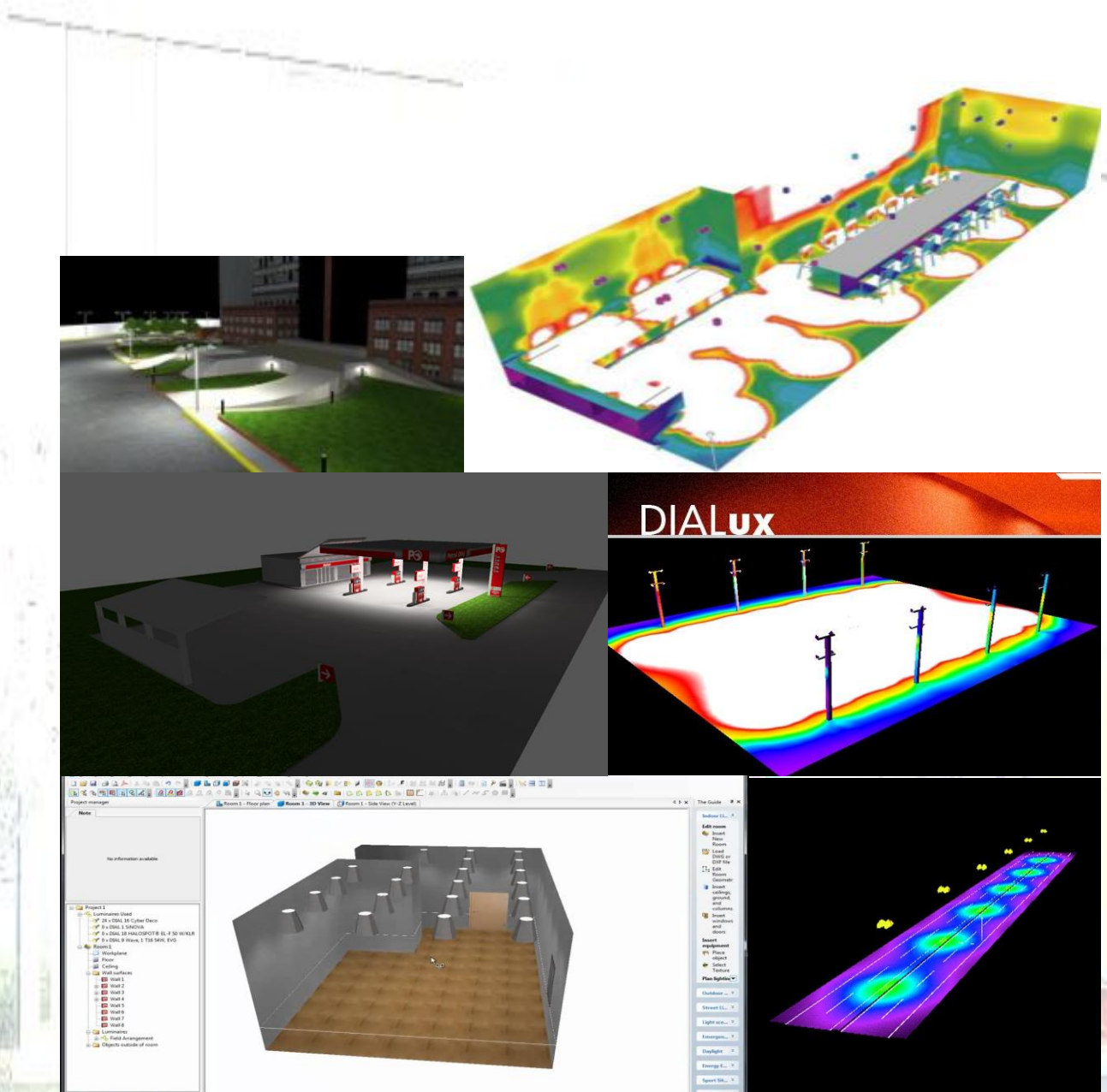

MANUFACTURING OF DECORATIVE POLES

- This section is specialized in the manufacture of decorative Poles of aluminum and Steel, for the gardens, streets and public squares...

On the other hand, herafion deals with HDG Octagonal, Conical and Fiber Glass street lighting poles.

All our lighting poles are recognized by MOMRA & SASO.



- All our lighting poles are recognized by SASO and tested by **BUREAU VERITAS**.

TEST METHODS:

BS ES 40-1

BS EN 40-3-1/2013

BS EN 40-3-2/2013 TEST LOAD, ACCEPTANCE CRITERIA

BS EN 40-3-3/2013 ACCEPTANCE OF DESIGN FOR DEFLECTION



BVSATS

OUR DESIGN



OUR DESIGN

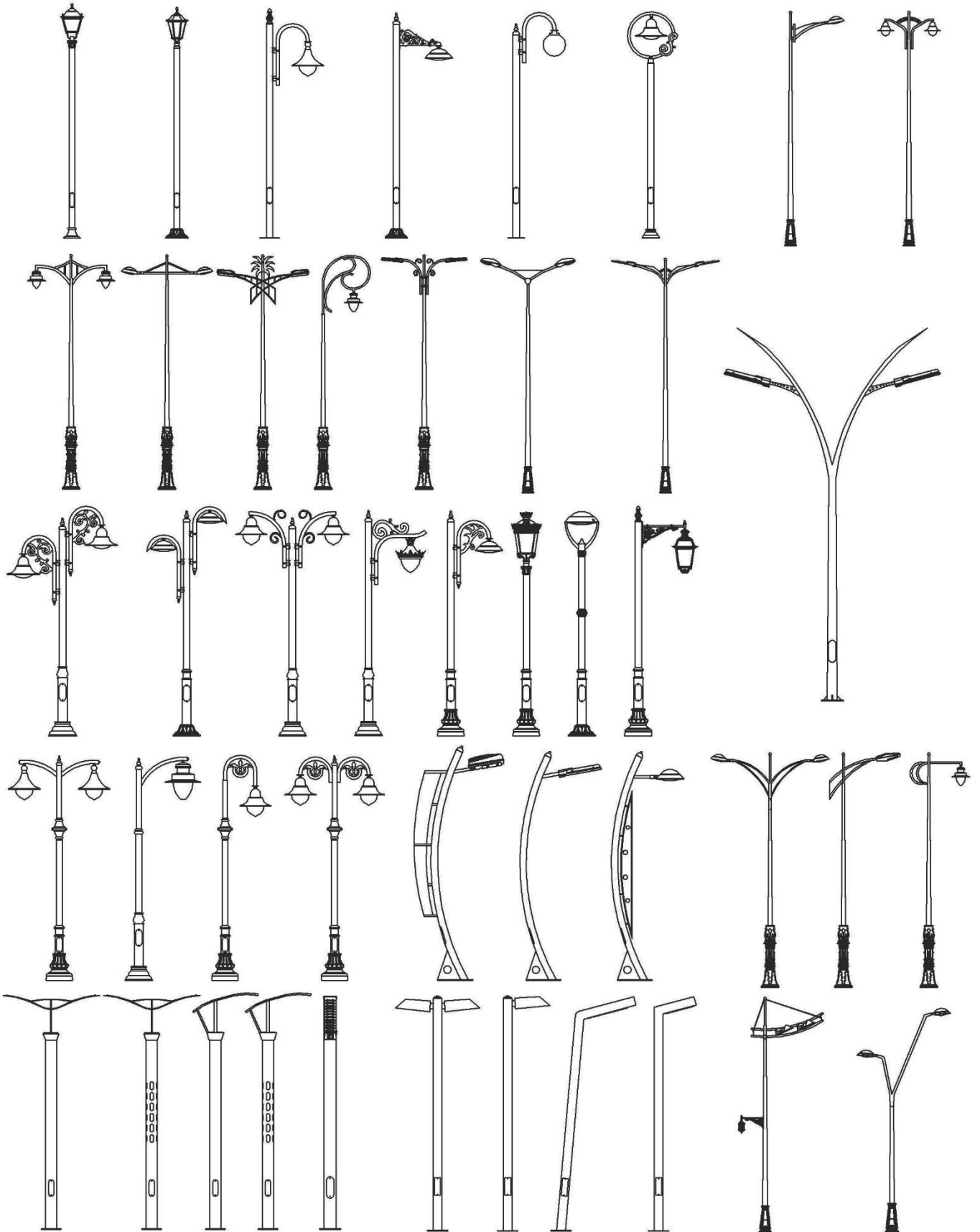

MADO LIGHT

EUROPEAN & GLOBAL BRANDS

AVILUX VS ROS illuminación ROBERS® SIBE®

onok lighting olympia electronics for a safer world JISO ILLUMINACION planlicht Liteplan emergency lighting LEDO LIGHT made in brilliance p.u.k. La Nave Fabricados

HOLDBOX Lighting & components essence... FaelLUCE having it better led lighting factory FLOS CORTEM GROUP ABB COOPER Lighting

COOPER CEAG BEIORAMA ares THE OUTDOOR BY FLOS ACB VENTILUX THE EMERGENCY LIGHTING SPECIALISTS valmont STANTON

TRQ TRONIX troll lighting your ideas TRILUM TM TECHNOLOGIE TCI professional led applications SOFI

smartengine | wtec secom here comes the light SIMES luce per l'architettura selux SAROS

REGENT Lighting coeLux albert WIBRE BIB Technology for Light Components - Optics - Automation ARKOSLIGHT

CASTAN Architectural Lighting Cariboni group Filippi illuminazione CO.SI.ME. EQUIPMENT FOR ATEX art metal FUMAGALLI since 1973

GUMARCRIS beşA afc

Ghm Crister architectural outdoor EBIR bathroom lighting dael atex LIGHTING SOLUTIONS FARO BARCELONA

Ghisamestieri the green way of light exo decorative indoor TAP EEC ELECTRONICS disano illuminazione ORBIT

PROLIGHT CONCEPTS GROUP LINERGY EMERGENCY LIGHTING HOLOPHANE LEADER IN LIGHTING SOLUTIONS DURALITE Hi-Tech Lighting Features ERCO ORBIK

Platek LIGHT-POINT COPENHAGEN LEIPZIGER LEUCHTEN KOILOT IVELA i b IBV HUNGÁRIA Lighting and Plastic Processing

PHILIPS OSRAM LUCE PLAN louis poulsen LM ELECTRONIC helestra Augenti

one LUX MAS LIGHTING oms NORLYS masia Mareli ltd LUCTRA

INHO MAURETZ indeluz technical indoor iGuzzini IGNIA LIGHT iC ICONE BEGA

INTERIOR

- RECESSED
- SURFACE
- PANEL
- KITCHEN
- WALL MOUNTED
- PENDANT
- BATHROOM
- FLOOR LIGHT
- PHOTO PANELS
- EMERGENCY
- INDUSTRY
- HAZARDOUS
- CRYSTAL CHANDELIERS
- BRASS CHANDELIERS



RECESSED

TECHNICAL



DIRECTIONAL



WATER TIGHT



AMBIANCE UGR



SURFACE

TECHNICAL



DIRECTIONAL



TRACK



PANEL



KITCHEN



WALL MOUNTED

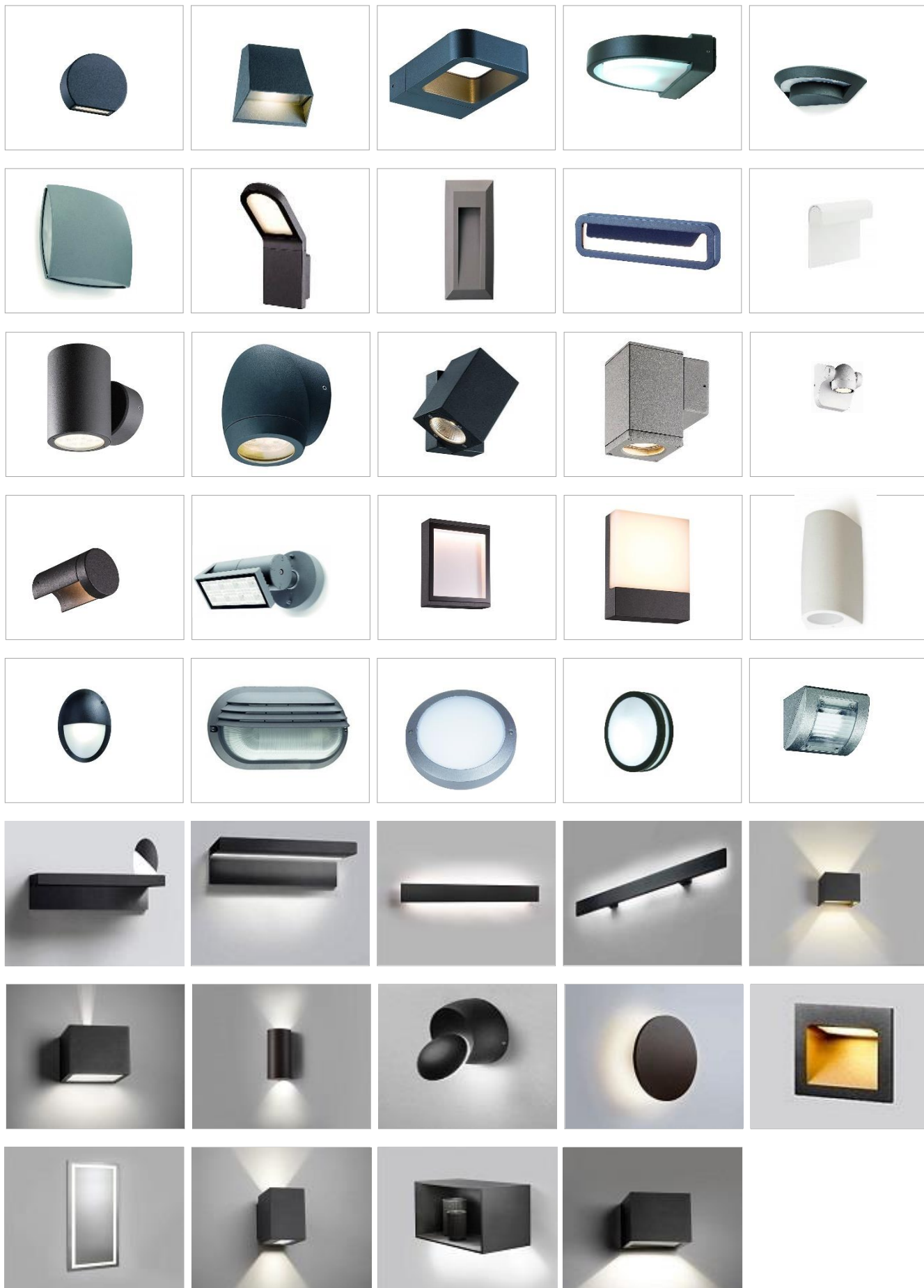

PENDANT

TECHNICAL



DECORATIVE

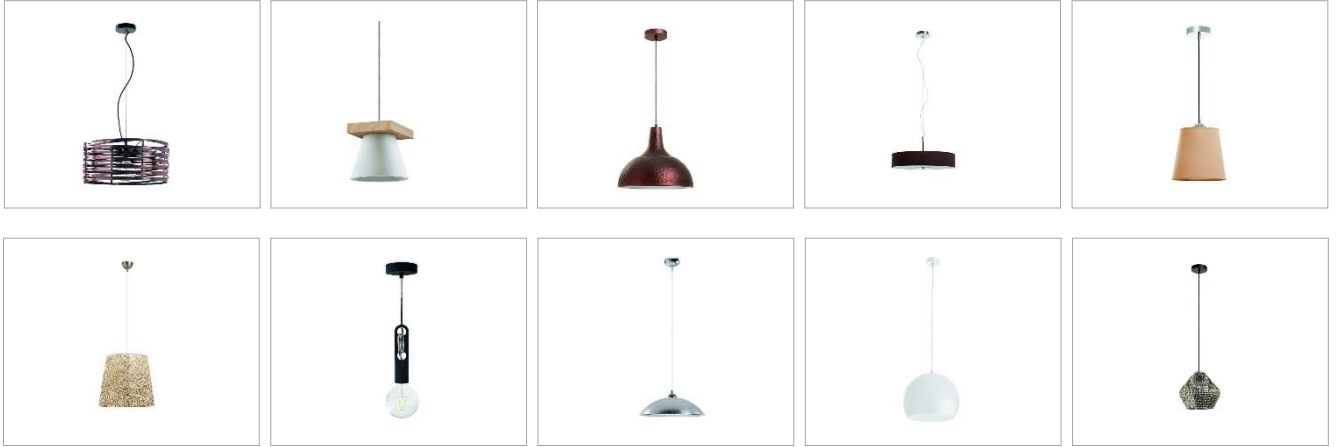

BATHROOM

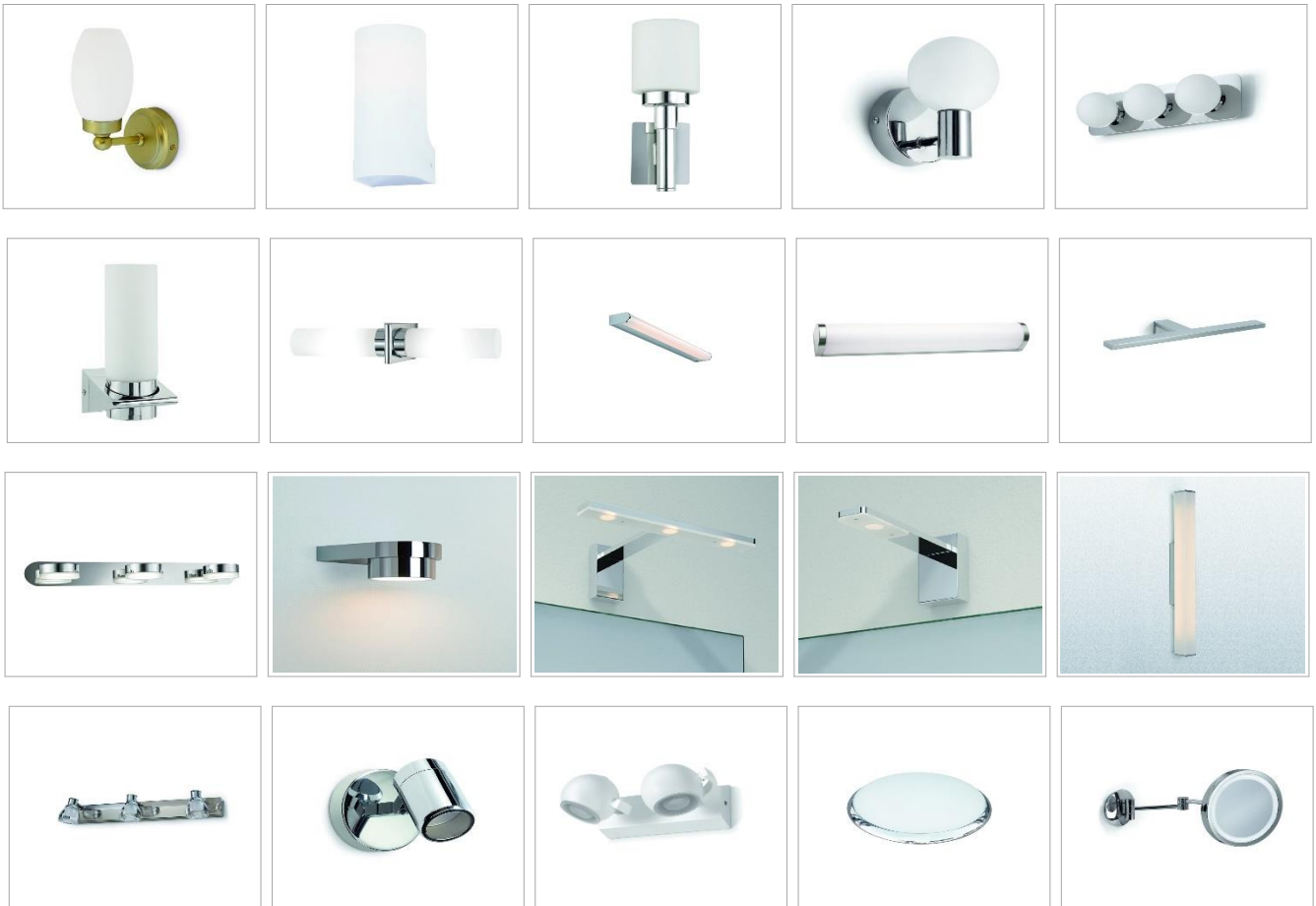

FLOOR LIGHT

LIGHT AS FLEXIBLE AS YOUR PERSONAL DAY.

LIGHT CAN BE ADJUSTED INTUITIVELY TO YOUR INDIVIDUAL NEEDS. WITH THE APP CONTROL SYSTEM, FLOOR BECOMES A FLEXIBLE TOOL. ON THE BASIS OF SIMPLE QUESTIONS ABOUT YOUR DAILY WORKING HABITS, THE APP CALCULATES YOUR PERSONAL LIGHT CURVE, WHICH IS TRANSMITTED TO THE LAMP VIA BLUETOOTH. THE INTENSITY AND COLOR OF THE LIGHT ARE REGULATED AUTOMATICALLY. THERE IS NO EASIER WAY.

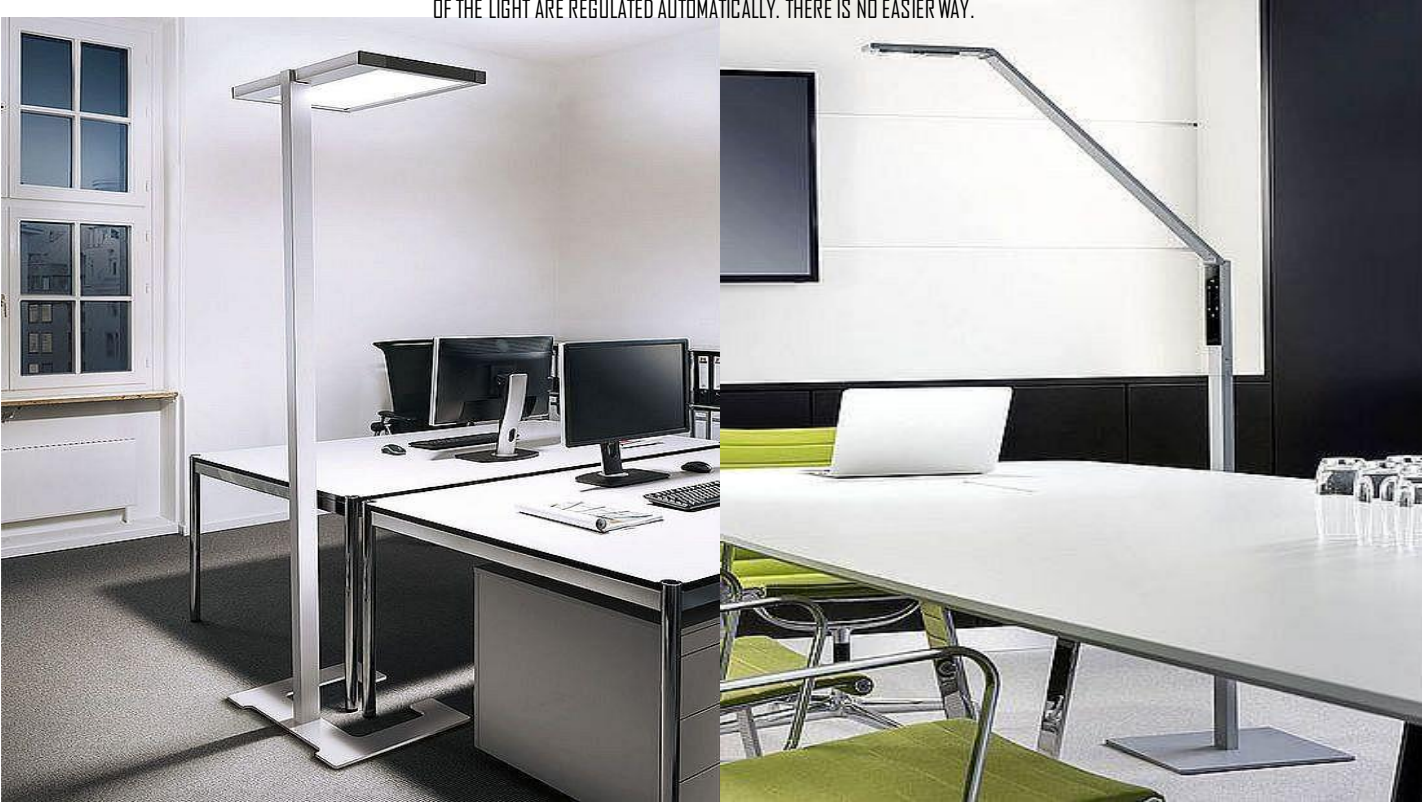

LED PHOTO PANELS

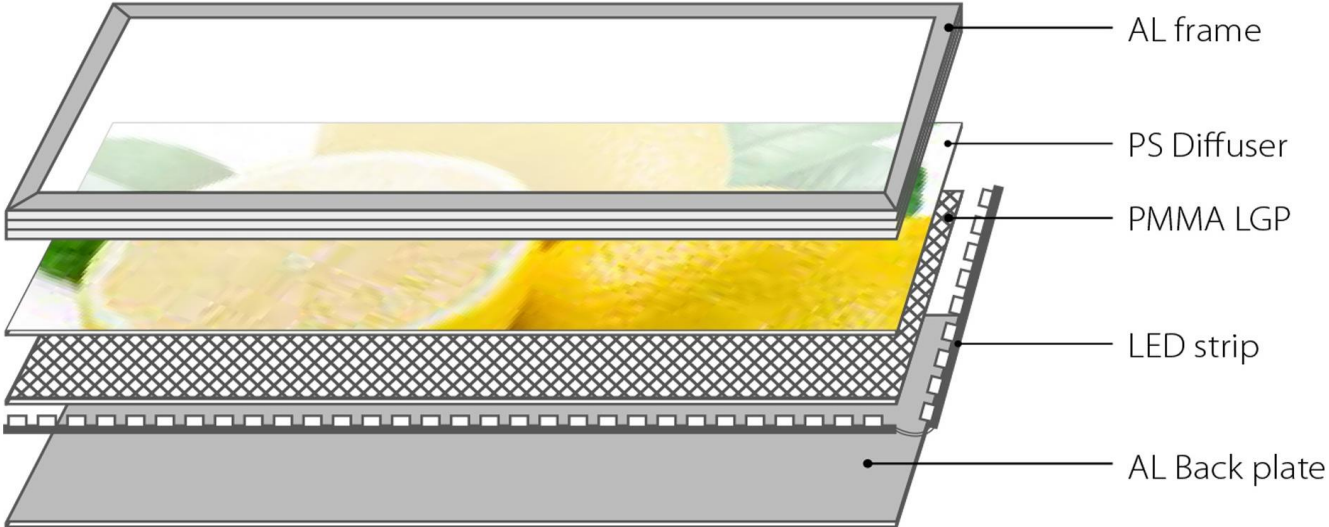

EMERGENCY



INDUSTRY



HAZARDOUS AREA



BRASS CHANDELIERS

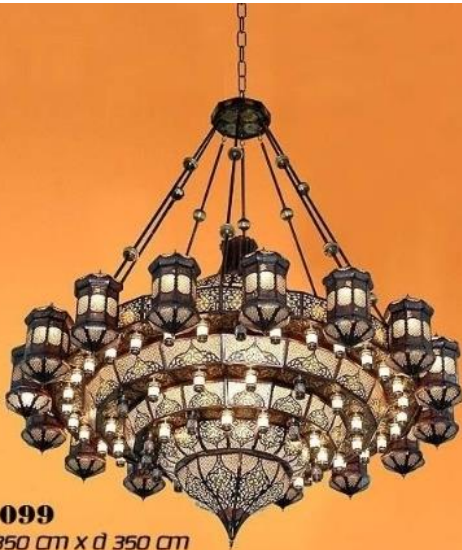

MS-0099
size h 350 cm x d 350 cm

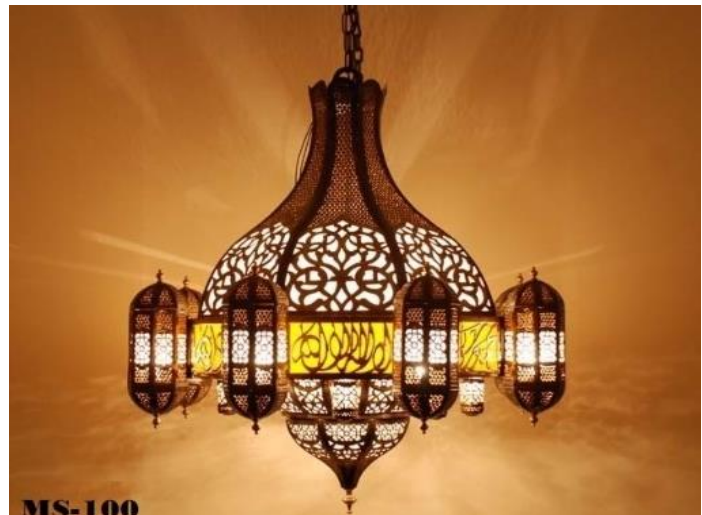

MS-100
size H 100 cm x d 100 cm



MS-098
size H 100 cm x d 60 cm



size H 185 cm x d 165 cm



MS-0048
size H 115 cm x d 95 cm



size H 85 cm x d 50 cm



size H 85 cm x d 35 cm



size H 60 cm x d 30 cm



size H 120 cm x d 75 cm



MS 0067
size H 100 cm x d 90 cm



size H 85 cm x d 70 cm



MS-108
size H 100 cm x d 90 cm



MS-0093
size H 9 cm x d 25 cm



size H 80 cm x d 25 cm



size H 140 cm x d 20 cm



size H 90 cm x d 25 cm



size H 90 cm x d 40 cm

EXTERIOR

- STREET POLES
- DECORATIVE POLES
- URBAN
- FLAG POLE
- BUILDING ELEMENT
- LUMINAIRES
- SKY PROJECTOR
- SMART POLE
- LANDSCAPE
- SOLAR

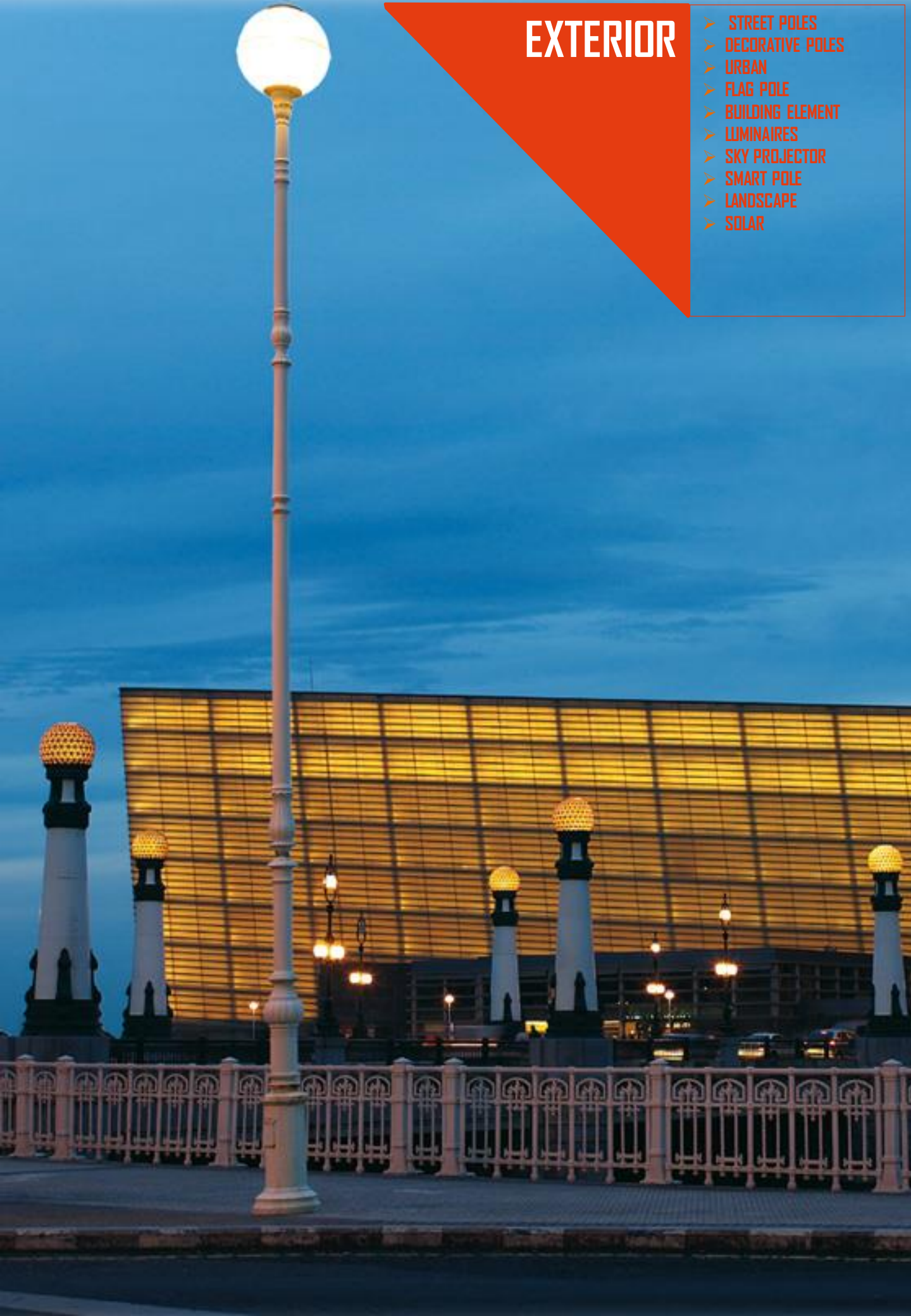

STREETS POLES

- **HIGHMAST POLES** With Raising & lowering Device , Ladder Cage Platform for Stadiums , Parks , Highways...
 - **HDG OCTAGONAL POLE**
 - **HDG CONICAL POLE**
 - **FIBER GLASS POLE**
- With Short,Long,Decorative Arms & Customized Arms Available Upon Request
POWDER COATING FINISH AVAILABLE UPON REQUEST

CURVE SHAPE



WOODEN POLE



DECORATIVE POLES

CLASSIC



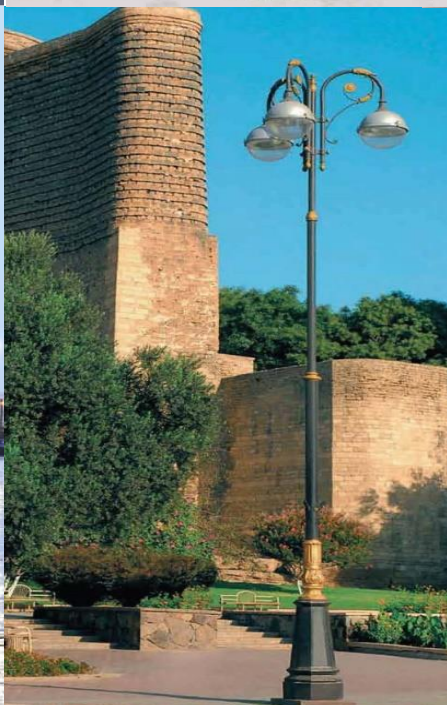

L SHAPE



ISLAMIC DESIGN

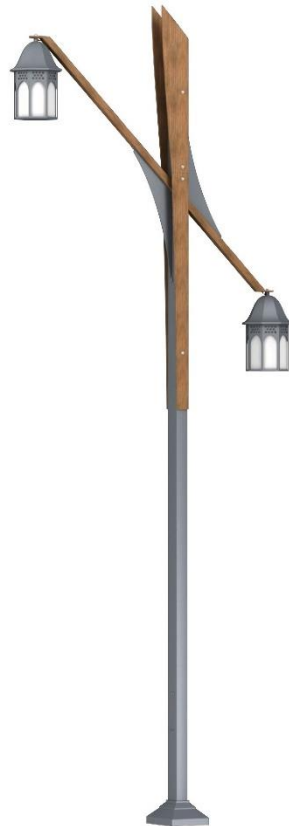

URBAN



ECLATEC



Ghm



ECLATEC



FLAG,CAMERA,TRAFFIC POLES



CUSTOM MADE SOLUTIONS



BUILDING ELEMENT

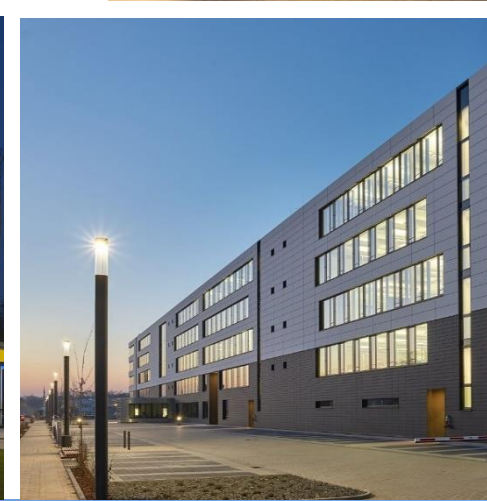
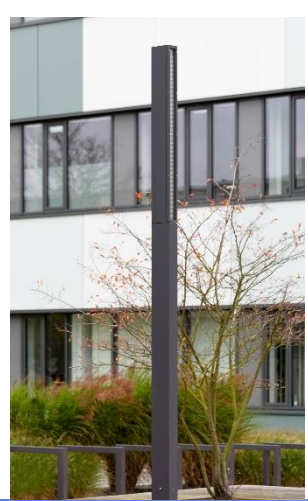
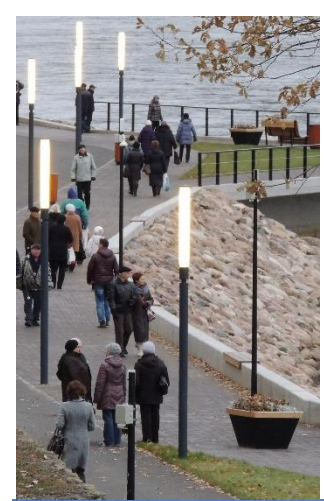

LUMINAIRES

GARDENS, PATHWAYS, PARKS



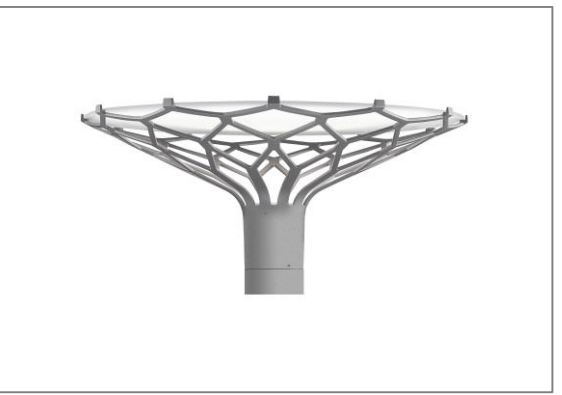
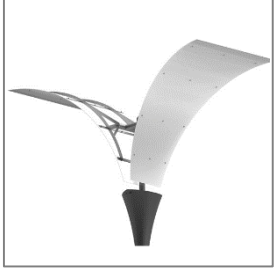

STREET - STADIUM - TUNEL

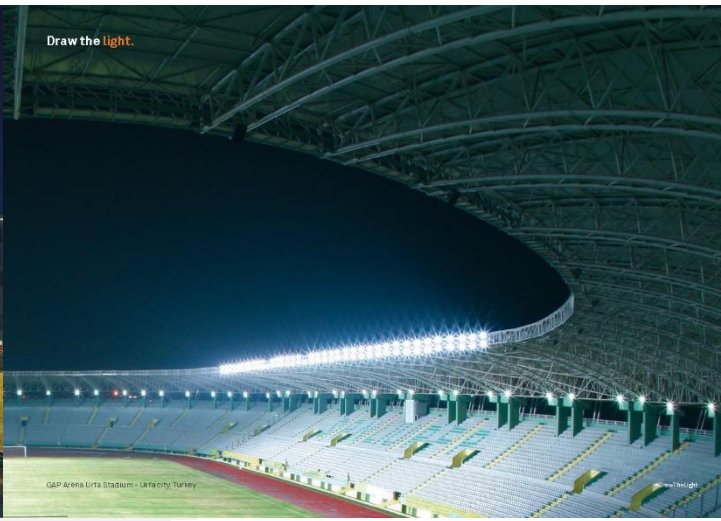
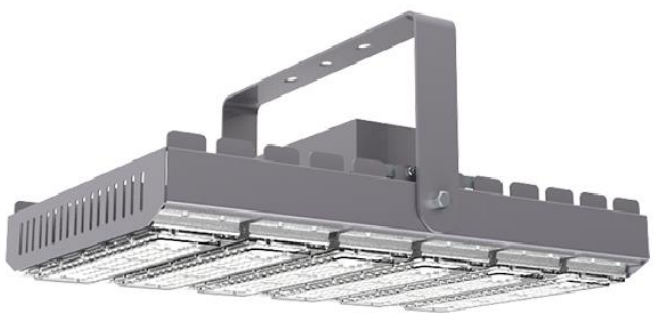

SKY PROJECTOR





WIFI
communication



CAMERA
security
500mm



CLEVER LIGHT
intelligent light management



LED TECHNOLOGY
lighting
FF, 700mm



LED TECHNOLOGY
lighting
FF, 500mm



LOUDSPEAKER
music and announcements



DISPLAY
multimedia



- 210mm x 250mm
- reading height: 1.40m – 1.60m
- HD ready (16:9)
- 1366 x 768 pixel
- 4mm thick clear toughened glass glazing against vandalism
- integrated within the rectangular profile

THE FUTURE IS NOW

The world has changed and there are huge expectations for urban areas. Only the ones who take this challenge as a chance will create an attractive environment with additional benefit for their residents, tourists and business people.

ALL-IN-ONE

What is the challenge? People want to be available everywhere, communicate in a fast way and easily recall all necessary information. At the same time, they want to feel comfortable and save and enjoy a relaxing atmosphere at a unique place. Necessary supply units for e.g. electronic cars or electronic bikes shall be easy accessible and blend in perfectly within the cityscape.

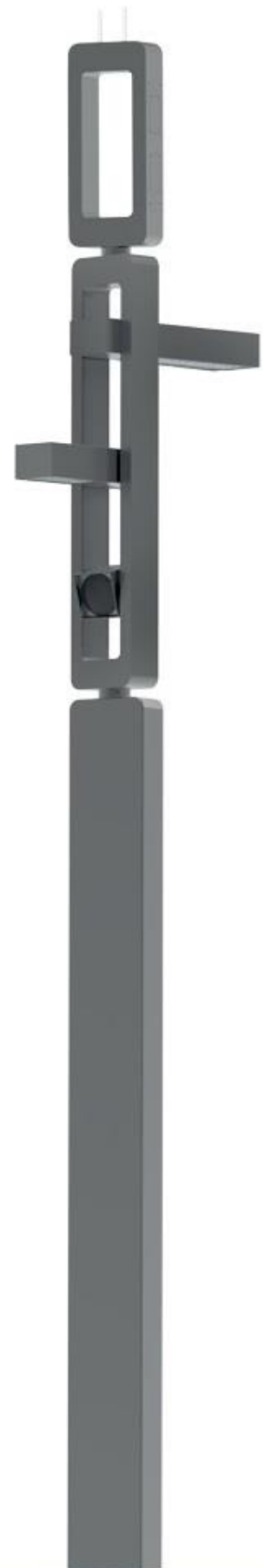

LANDSCAPE

BOLLARDS



BULKHEAD/WALL MOUNTED



STEP LIGHT



FloodLight



SPIKE



UPLIGHT



UNDERWATER



WALL WASHER



LED STRIP

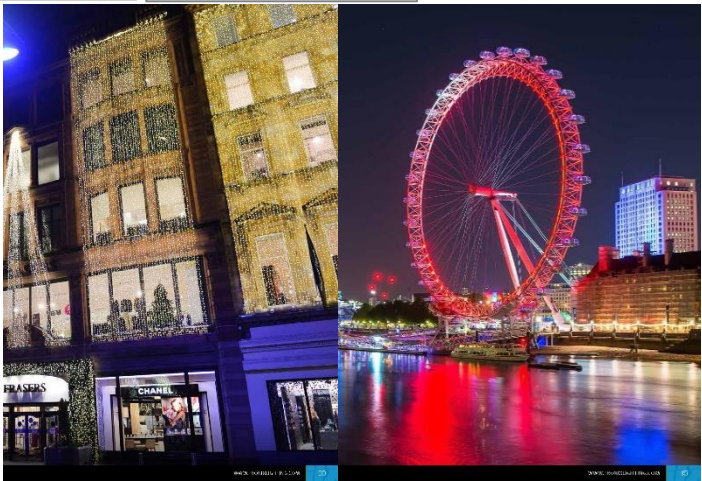

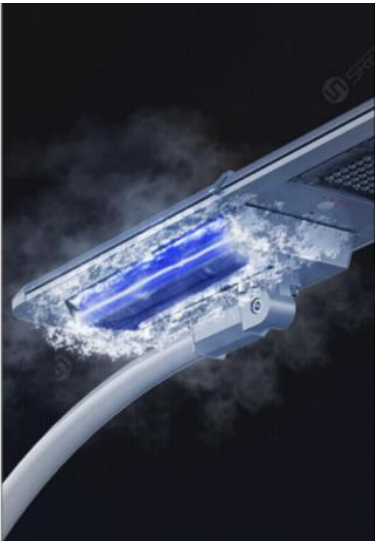

HIGH-TEMPERATURE PROTECTION

Battery Lifespan in high temperature area is longer as one feature will prevent battery still being charged at abnormal Hot environment.

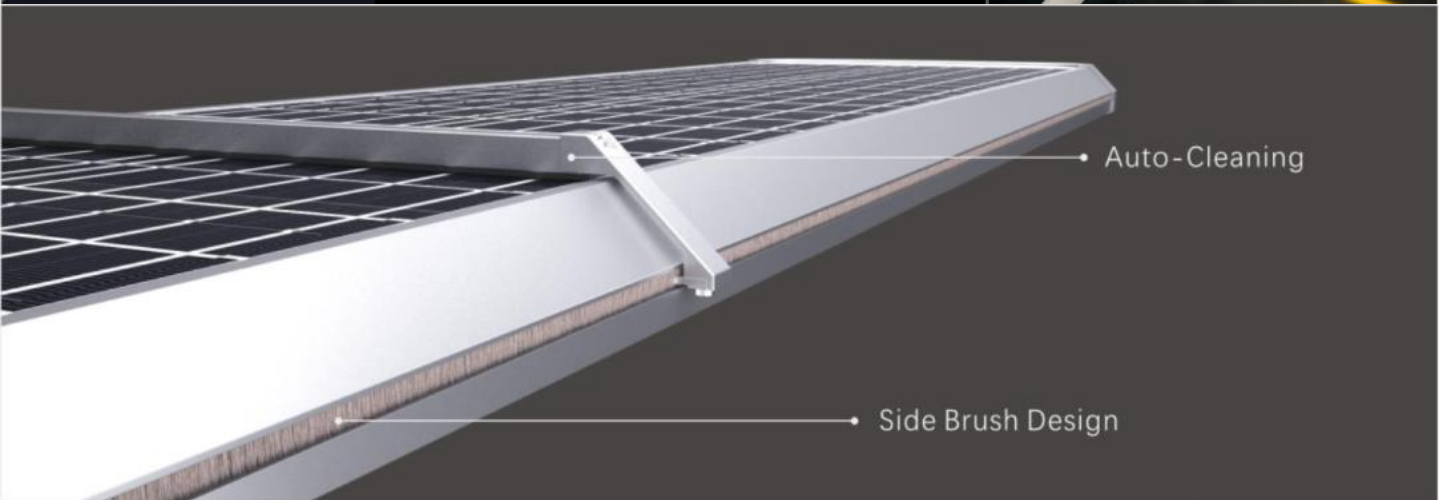



SOLAR LED STREET LIGHT

THE USE OF THE POWER OF THE SUN IS A GREAT CHALLENGE. THE AUTONOMOUS LIGHTS OF THE SS FAMILY PROVIDE YOU WITH THIS FACILITY.

YOU MAY USE SS9A-8C-GV3 FOR LIGHTING DIFFERENT PUBLIC AND PRIVATE SITES, STREETS, PARKS, ALLEYS, QUAYS, AREAS BETWEEN BUILDINGS – FREE OF TAKING CARE ABOUT THEIR MAINTENANCE.

SS9A-8C-GV3 IS AN INNOVATIVE, HIGH-TECH PRODUCT WITH A MODERN DESIGN AND UNIVERSAL APPLICATION FOR LIGHTING DIFFERENT AREAS.



False Colours
 illuminances

	16.00 lx
	14.00 lx
	12.00 lx
	10.00 lx
	8.00 lx
	6.00 lx
	4.00 lx
	2.00 lx
	0.00 lx

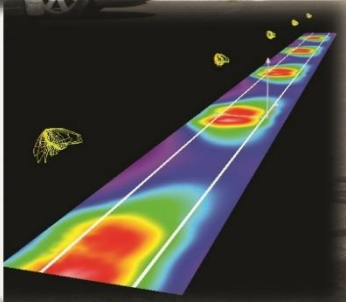



Pioneers of Quality Systems & Certifications

CERTIFICATE



This is to Certify that the Managements System of
HERAFION LIGHTING TRD CO

Office 57 , 5th Floor , Technical Center Bldg, Jeddah, Kingdom of Saudi Arabia

Has been assessed and found to be in accordance with the management system requirements in

ISO 9001:2015

This certificate is valid for the following scope of operation:

Selling indoor and outdoor lighting, gardens, buildings, streets and tunnels, decorative poles, street poles and their accessories

Certificate No.:

PQS/C01/SA061121

Initial Date of Certification: 06-11-2021

1st Surveillance Audits Due on: 06-10-2022

Date of Certificate: 06-11-2021

2nd Surveillance Audits Due on: 06-10-2023

Date of Expiry: 06-10-2024

This certificate remains valid subject to satisfactory surveillance audit.

MANAGING DIRECTOR



CERTIFICATION MANAGER

For Verification & Updated information concerning
the present certificate visit to

PQS website:

www.pqscert-eg.com

IAF website:

<https://www.iafcertsearch.org>



الهيئة السعودية للمواصفات والمقاييس والجودة
Saudi Standards, Metrology and Quality Org.

Projects References and Approval Letter

AP_Id	Date	Contractor	ProjectName	Owner	Consultant
1001	09/05/2016	Alharamain & Sons Co	Al Yamamah Street Walk	Amana Jeddah	Parsons
1002	21/01/2018	Saudi Abv	King Abdulaziz University Jeddah 285	King Abdulaziz Univer	Saudi Consultant
1003	30/09/2017	Saudi Abv	King Abdulaziz University Jeddah 285	King Abdulaziz Univer	Fluor Arabia Ltd
1004	30/04/2018	Rabya Landscape	Private Project In Alsafa Jeddah	Amana Jeddah	Khatib & Alami Co
1005	03/11/2016	Amana Asir	General Approve	Amana Asir	Amana Asir
1006	02/01/2017	Makan Co	King Abdulaziz University Jeddah J13	Makan Co	Fluor Arabia Ltd
1007	12/02/2014	Alraedah Co	Al Raidah Housing Complex	Rahadah Investment C	Saudi Consultant
1008	05/08/2017	Amana Jizan	Corniche Jizan	Amana Jizan	Amana Jizan
1010	24/05/2015	Nesma Water & Energy	Kaec Almuruj	Emaar	Ace Consulting Engineers
1011	28/12/2014	Hamza Eldiri Co	General Approve	Amana Jeddah	Amana Jeddah
1012	29/05/2014	Saudi Binladen Group	Shamiya Extension / Security Building	Saudi BinLadin Group	International Eng. Consultant
1013	12/11/2015	Al Selouly Agricultural Est.	Public Gardens & Walkway In Jeddah	Amana Jeddah	Parsons
1014	05/11/2015	Amana Jeddah	General Approve	Amana Jeddah	Amana Jeddah
1015	17/01/2014	Al-rajhi Infrastructure	Kaec Talah Gardens 1	Emaar	Saudi Consultant
1016	25/06/2014	Haramain Gate	Damac Esclusiva -riyadh	Damac	Salama Siruciural Engineers
1017	04/08/2014	Shining Crown For Contracting	Construction Of Gardens Walkway Je	Amana Jeddah	Parsons
1018	09/07/2014	Saudi Landscape	Constrution Of Municipal Courts	Amana Jeddah	Parsons
1020	22/06/2014	Rezaik Al-gedrawy	Infrastructure	Emaar	Ehaf Consulting Engineers
1021	20/08/2014	Shining Crown For Contracting	Constrution Of Pedestrians Walks In	Amana Jeddah	Parsons
1022	25/08/2014	Salco	El-saif Beach Jeddah	Amana Jeddah	Parsons
1024	02/02/2015	Nesma Water & Energy	Almurooj Beach Community 2	Emaar	Arab Cnsulting Engineers
1027	16/01/2014	Rezaik Al-gedrawy	Al Waha Vip 1	Emaar	Engineer Consultant Group
1028	26/03/2014	Rezaik Al-gedrawy	Beach Community1 (bc1)	Emaar	Engineer Consultant Group
1030	25/12/2017	SAUDI ABV GENERAL CONTRA	COMPLETION OF RESEARCH CENTER KING ABDULLAZIZ UNI	FLUOR ARABIA LTD.	
1031	20/04/2019	MOBCO CIVIL CONSTRUCTION	CHAMBER OF COMMERCE & INDUST	CHAMBER OF COMME	ARCHITECTURE & PLANNING GRC
1032	27/12/2021	AFNAN TRADING AND CONTR	MAINTENANCE OF FACILITIES AND P	AMANA JEDDAH	ZUHAIR FAYAZ PARTNERSHIP
1033	06/04/2021	FUTURE CREATORS CONTRAC	KING ABDLLAH SPORT CITY PITCH .N	Ministry Of Sports	Ministry Of Sports
1034	14/10/2021	BUILT CONTRACTING COMPA	JAWHARAT AL RUSEIFA PROJECT	Ministry Of Housing	OTCE SAUDI ENGINEERING CONS
1035	30/07/2019	REZAIK AL GEDRAWY CONTRA	DAR AL JEWAR RESIDENTIAL COMMML	KNOWLEDGE ECONO	DAR AL OMRAN
1036	20/10/2020	ADVANCED CONSTRUCTION C	DEVELOPING THE INTERSECTION OF	AMANA JEDDAH	LOUIS BERGER
1037	23/02/2020	AL SOUMALI CONTACTING CO	HOUSING COMPLEX MADINA	SALINE WATER CONVE	TAIBA CONSULTING CENTER
1038	28/01/2021	ENGINEERING HOUSE CO	JAZAN SAUDI NAVAL BASE	Saudi Naval Forces	SAUDI CONSULT
1039	09/04/2021	GENERAL APPROVAL	GENERAL APPROVAL	AMANA DAMMAM	GENERAL APPROVAL
1040	27/02/2021	SEMACOM CO	AL TAHLIA GATE	AMANA JEDDAH	AL OMRANIAH CONSULT
1041	08/10/2020	ADVANCED CONSTRUCTION C	CONSTRUCTION OF BRIDGE INTERSE	AMANA JEDDAH	LOUIS BERGER
1042	07/03/2019	SALEM SALEH HARETH EST	AL BAHR ALHMAR BOULEVARD	EMAAR	H D R
1043	15/08/2019	CAPITAL NURSERIES COMPAN	MAINTENANCE OF THE WATERFRON	AMANA JEDDAH	ZUHAIR FAYAZ COMPANY AND A
1044	22/09/2020	BASTANA CO	RAYAT OBHOR	AMANA JEDDAH	ABDULLAH NASER CONSULTING
1045	31/01/2019	AL SOUMALI CONTACTING CO	SALINE WATER CONVERSION HOUSI	SALINE WATER CONVE	TAIBA CONSULTING CENTER
1046	15/04/2018	RABYA CO	ALSafa GARDENS	AMANA JEDDAH	KHATIB & ALAMI
1047	09/12/2020	MOBCO CIVIL CONSTRUCTION	AS SAFIYAH AH MUSEU&PARK	AS SAFIYYAH REAL STA	ALTURATH URBAN ENGINEERING
1048	16/06/2019	ARABIAN INITIAL CO	AL TAHLIA GATE	AMANA JEDDAH	PROJECTS URBAN ENGINEERING
1049	10/11/2020	ADVANCED CONSTRUCTION C	CONSTRUCTION OF TUNNEL	AMANA JEDDAH	LOUIS BERGER
1050	22/03/2022	PILLAR CO	ALRASS HOUSING COMPLEX	Ministry Of Housing	KHATIB & ALAMI
1051	02/05/2020	HAMZA AL DERI CO	AL CORNICHE COMMERCIAL CENTER	AWJ REAL STATE COM	AWJ REAL STATE COMPANY
1052	20/10/2021	ADVANCED CONSTRUCTION C	CONSTRUCTION OF TUNNEL	AMANA JEDDAH	LOUIS BERGER
1053	04/01/2021	SULTAN ALI KHISHAN ALHARB	MAINTENANCE OF FACILITIES AND P	AMANA JEDDAH	ZUHAIR FAYAZ
1054	19/01/2015	NESMA WATER & ENERAV	AL MRUROOJ BEACH COMMUNITY 2	EMAAR	ARAB CONSULT ENGINEER
1055	23/03/2022	AFNAN TRADING AND CONTR	MAINTENANCE OF FACILITIES AND P	AMANA JEDDAH	ZUHAIR FAYAZ
1056	29/05/2022	DOSSR ALSAHRAA CO	MASHARF 2	AMANA JEDDAH	ZUHAIR FAYAZ
1063	21/04/2022	BASTANA CO	MASHARF 2	AMANA JEDDAH	ZUHAIR FAYAZ
1058	11/06/2020	AL SOUMALI CONTACTING CO	SALINE WATER CONVERSION HOUSI	SALINE WATER CONVE	TAIBA CONSULTING CENTER
1059	19/02/2020	AL SOUMALI CONTACTING CO	SALINE WATER CONVERSION HOUSI	SALINE WATER CONVE	TAIBA CONSULTING CENTER
1062	23/03/2019	AL SOUMALI CONTACTING CO	SALINE WATER CONVERSION HOUSI	SALINE WATER CONVE	TAIBA CONSULTING CENTER
1064	27/12/2022	BASTANA CO	MASAR	AMANA MAKKAH	KEO
1065	26/09/2022	CAPITAL NURSERIES COMPAN	MAINTENANCE OF THE WATERFRON	AMANA JEDDAH	ZUHAIR FAYAZ

*Note: Approval Letter Copy available upon Request

GALLERY



JEDDAH ALSAFA GARDEN



JEDDAH UNIVERSITY PARK



RAFHAH PARK



JEDDAH ALSAIRAFI ROAD

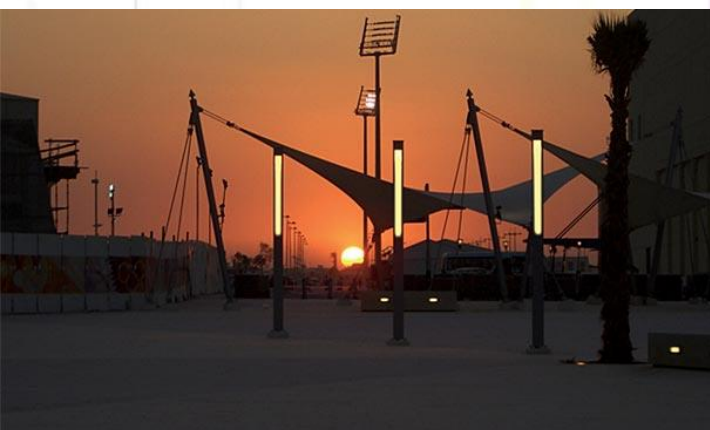

JEDDAH CORNICE



JEDDAH CORNICE COMPOUND



KAEC ALMURUJ



KAALU



ABHAA



ALMADINA MUNAWARAH



ALTAEF PARK



KAEC TALA



BOUREIDAH



JEDDAH ALRIHAB



JEDDAH SARI PARK



MAKKAH ALRAJHI MOSQUE



JEDDAH JCCI



KAEC GOLF

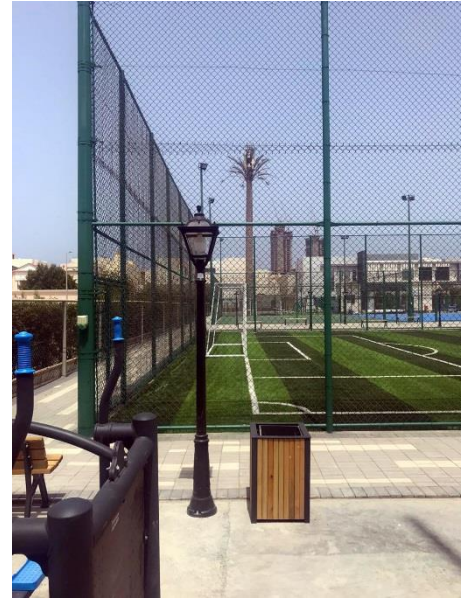

Jeddah stadiums



Prince Fawaz Compound



King Abdulaziz University



MADO
LIGHT



puk.
Italian Architectural Lighting

JISO
ILUMINACION
SPAIN

AVILUX

onok

MAS
LED
LIGHTING

Millennium Hotel _ Makkah

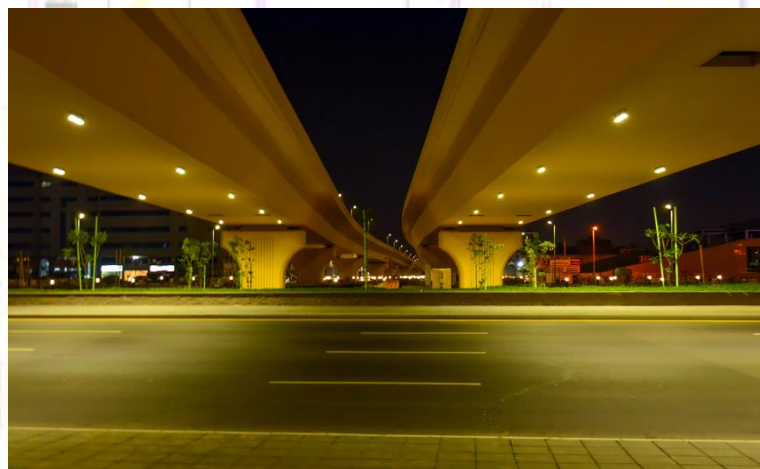
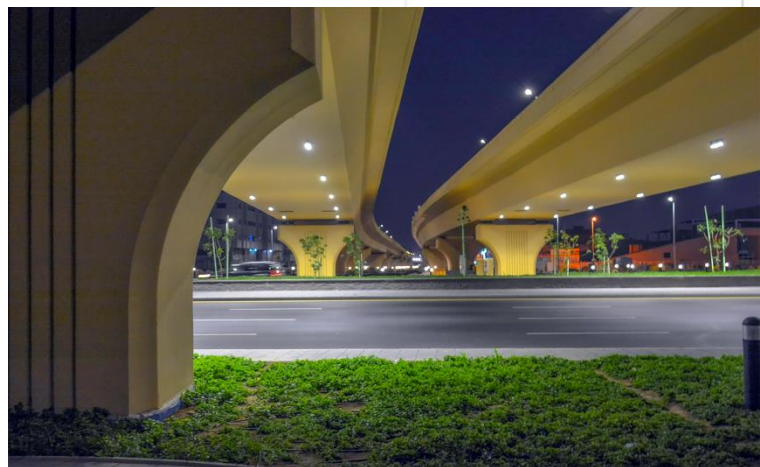

Intersection Talia & Madinah



Ministry of Housing _ Al-Jawhara Housing Jeddah

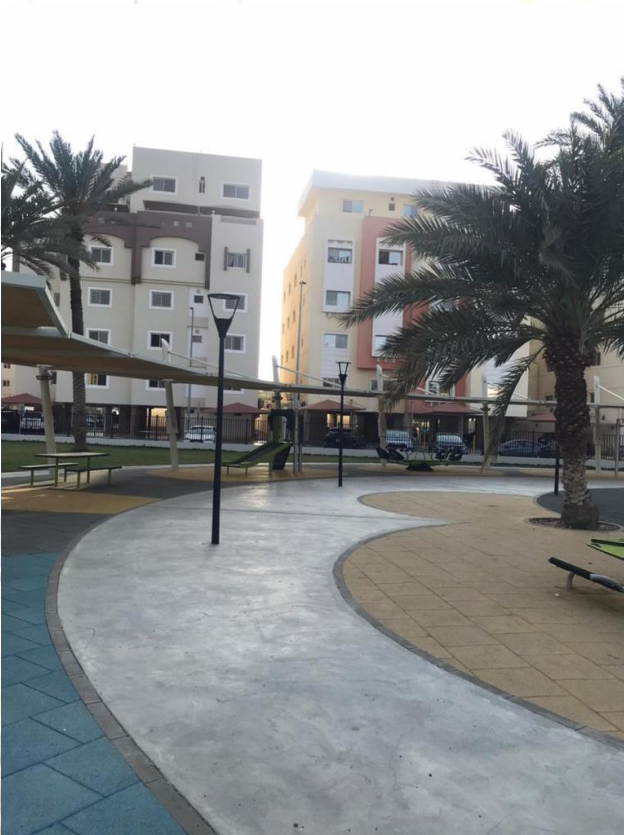

Alhamra Park



Obhor Park



Ministry of Housing _ Sama Jeddah



Compound Masharif_2



Sondus Park

ORGANIZATION CHART

Our Organizational structure has been custom-made to organize, categorize and delegate our tasks to achieve our goals. This structure determines how we make our decisions and implemented them at all levels of our business.

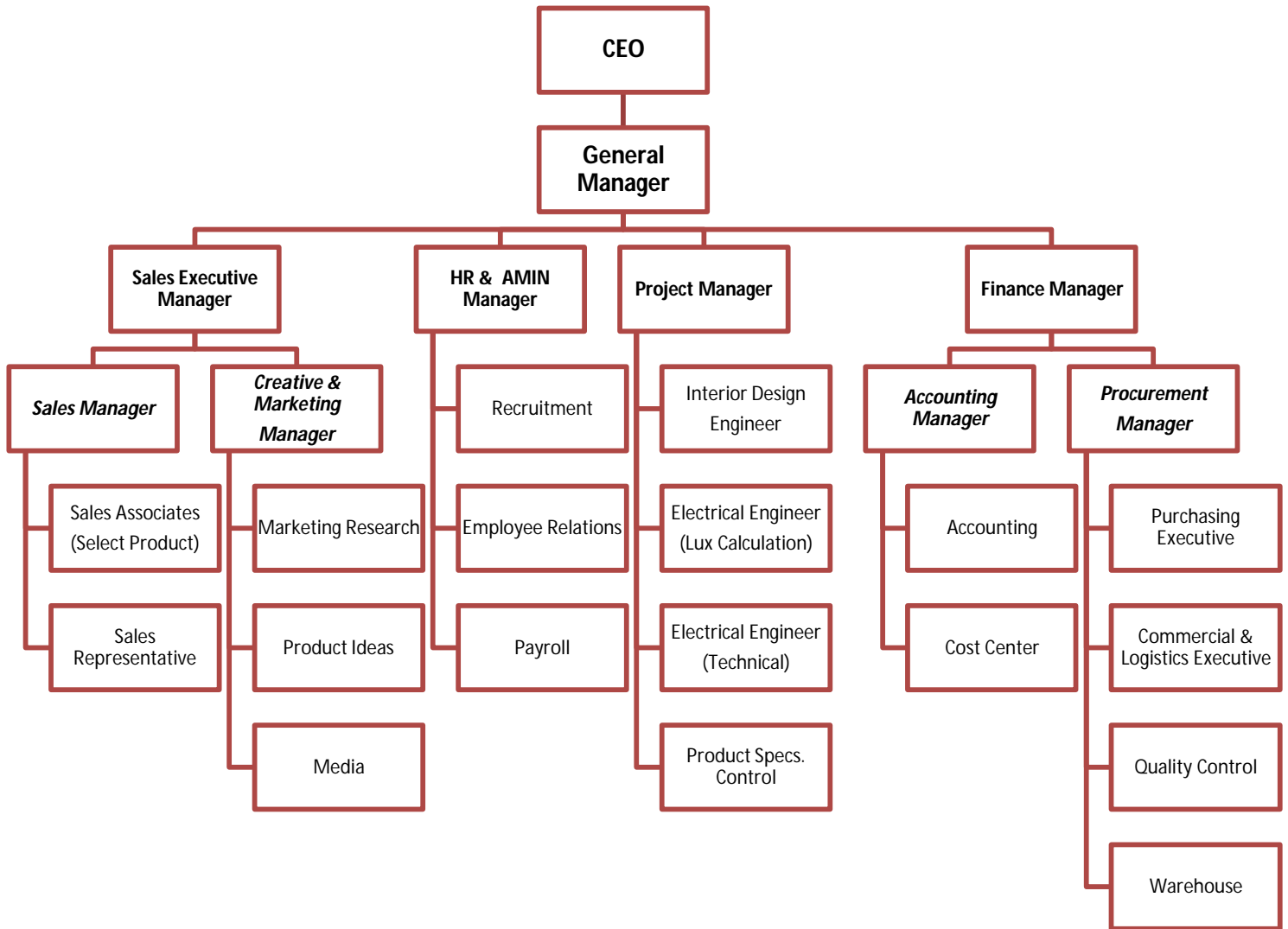

COMPLIANCE

- We do Comply with all BS, and IEC Codes.
- We Comply with materials and equipment standard.
- We assure you that we provide high-quality services and accessories to Complete your job in best & suitable economical way. Our aim is to build a good business relationship with you in the near Future

CONTACT REFERENCE

GENERAL MANAGER

MR.MOHAMAD HASSAN
M.HASSAN@MADOLIGHT.COM

SALES MANAGER

MR.EHAB MAHMOUD
EHAB.M@MADOLIGHT.COM

ACCOUNTING MANAGER

MR.AHMAD MOHAMAD
ACCOUNTING@MADOLIGHT.COM

PROJECT MANAGER

ENG.FADI ELHAJJ
PROJECTS@MADOLIGHT.COM

REGISTRATION CERTIFICATES

- We are committed to the terms of the government :
- 1-CR 4030595507
 - 2-JCCI 277821
 - 3-VAT 310126280900003
 - 4-Social Insurance
 - 6-Certificate of Zakat

Note: Copies Available Upon request

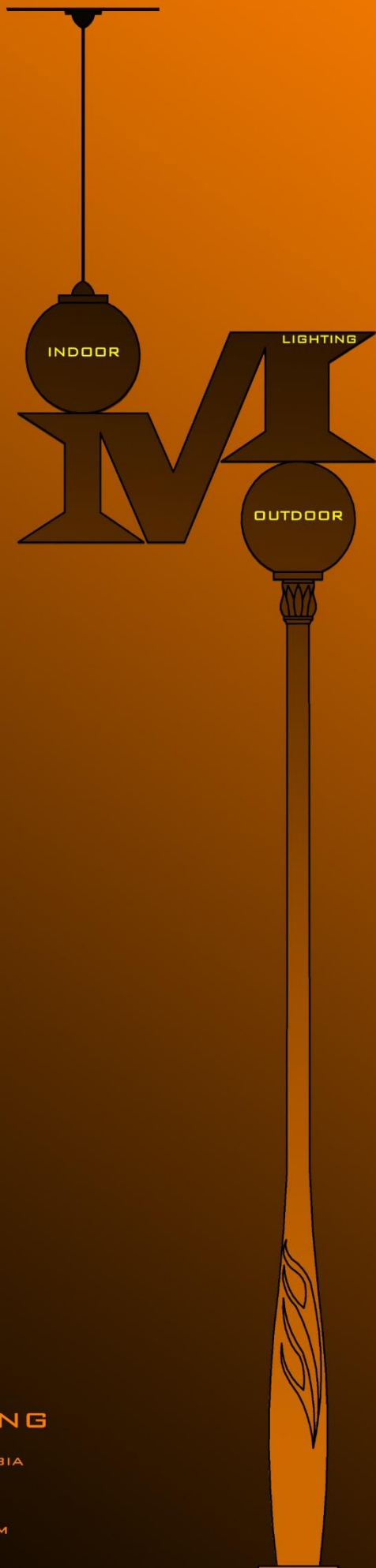

HERAFION LIGHTING

JEDDAH - KINGDOM OF SAUDI ARABIA

TEL: +966 12 261 6641

E-MAIL: HERAFION@MADDLIGHT.COM

WWW.MADDLIGHT.COM