

INDOOR & OUTDOOR

MIADO
LIGHT

MADO LIGHT

EUROPEAN & GLOBAL BRANDS

A comprehensive grid of lighting brand logos. The logos are arranged in approximately 10 rows and 10 columns. Brands include: VYRZYCH, VS, LUX, ROS, ROBER, SIBE, onok, JISO, planlicht, Liteplan, LEDO, p.u.k., La Nave, HOLDBOX, FaelLUCE, led lighting factory, FLOS, CORTEM, ABB, COOPER Lighting, COOPER CEAG, BEIORAMA, ares, ACB, VENTILUX, valmont, TRQ, TRONIX, troll, TRILUM, TM TECHNOLOGIE, TCI, SOFI, smartengine, wtec, secom, SIME S, selux, SAROS, REGENT, coeLux, albert, WIBRE, BIB, ARKOS LIGHT, CASTAN, Cariboni, Filippi, CO.SI.ME., art metal, GUMARCRIS, beşA, afc, FUMAGALLI, Ghm, Crister, EBIR, dael, atex, FARO, Ghisamestieri, exo, TAP, EEC, disano, ORBIT, PROLIGHT, LINERGY, HOLOPHANE, DURALITE, ERCO, Platek, LIGHT-POINT, LEIPZIGER LEUCHTEN, KOILOT, IVELA, i b IBV HUNGÁRIA, PHILIPS, OSRAM, LUCE PLAN, louis poulsen, LM ELECTRONIC, helestra, Augenti, one LUX, MAS LIGHTING, OMS, NORLYS, masia, Mareli ltd, LUCTRA, INHO MAURETZ, indeluz, iGuzzini, IGANIA, iC, BEGA.

INTERIOR

- RECESSED
- SURFACE
- PANEL
- KITCHEN
- WALL MOUNTED
- PENDANT
- BATHROOM
- FLOOR LIGHT
- PHOTO PANELS
- EMERGENCY
- INDUSTRY
- HAZARDOUS
- CRYSTAL CHANDELIERS
- BRASS CHANDELIERS



RECESSED

TECHNICAL



DIRECTIONAL



WATER TIGHT



AMBIANCE UGR



SURFACE

TECHNICAL



DIRECTONAL



TRACK



PANEL



KITCHEN



WALL MOUNTED

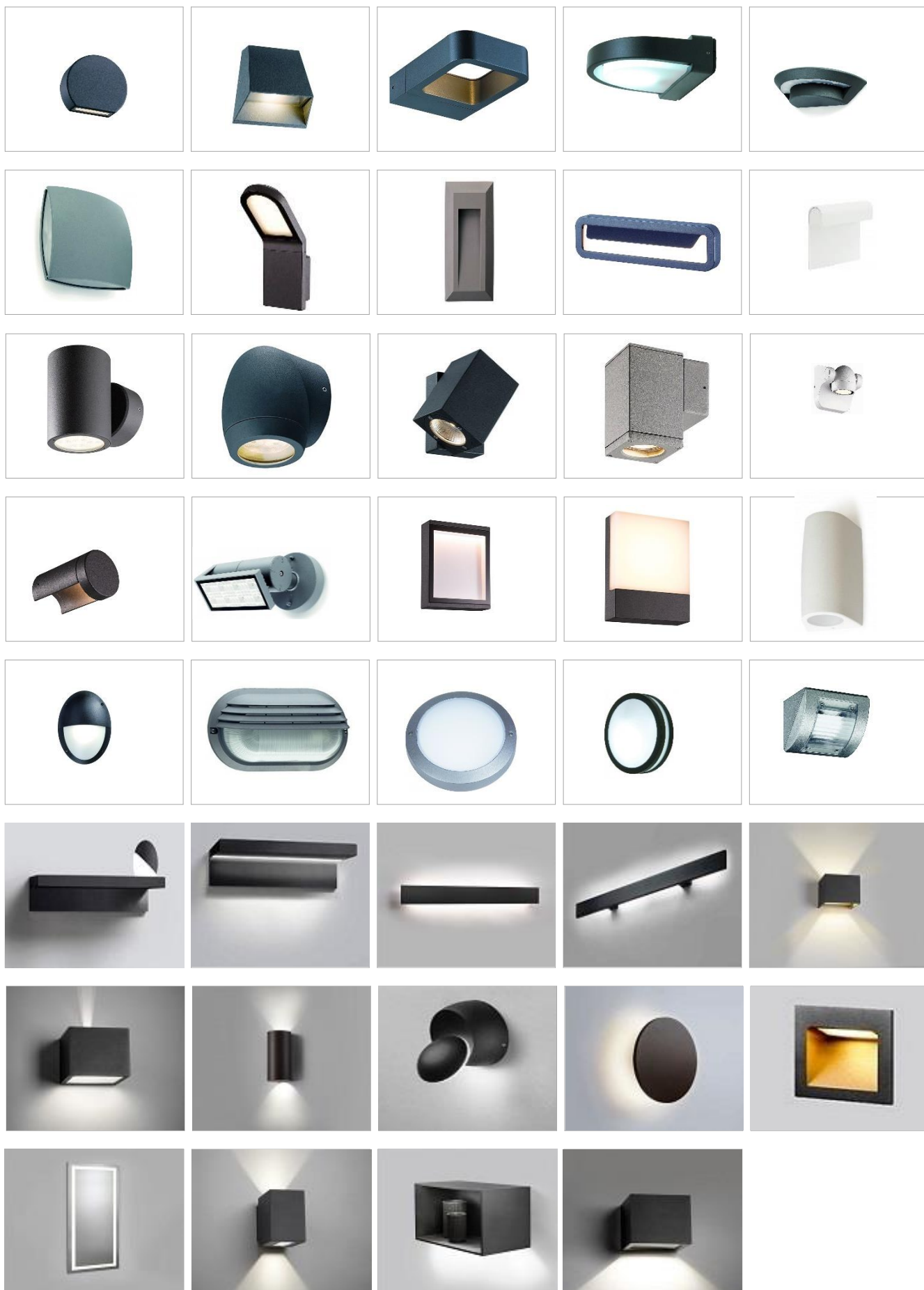

PENDANT

TECHNICAL



DECORATIVE

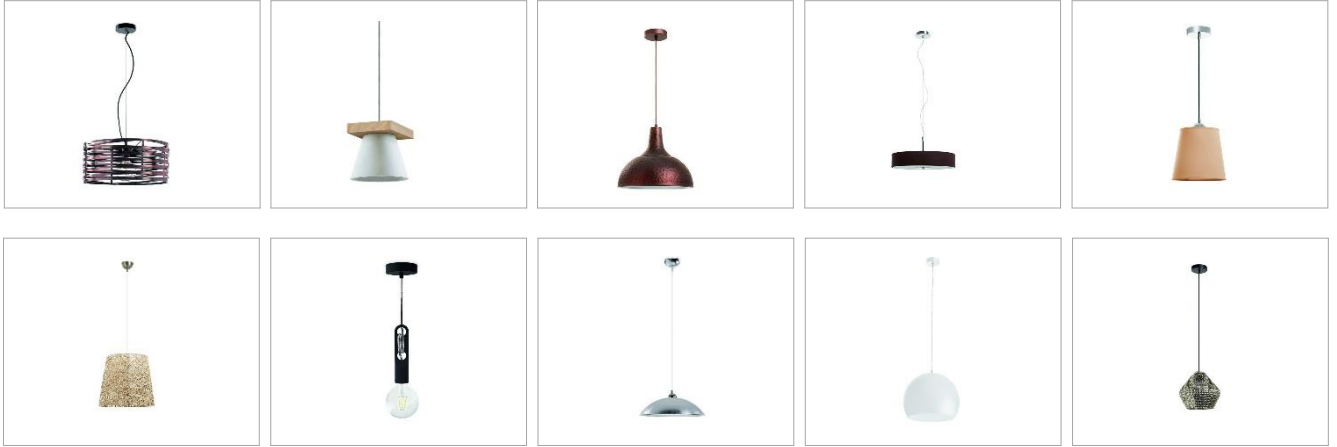

BATHROOM

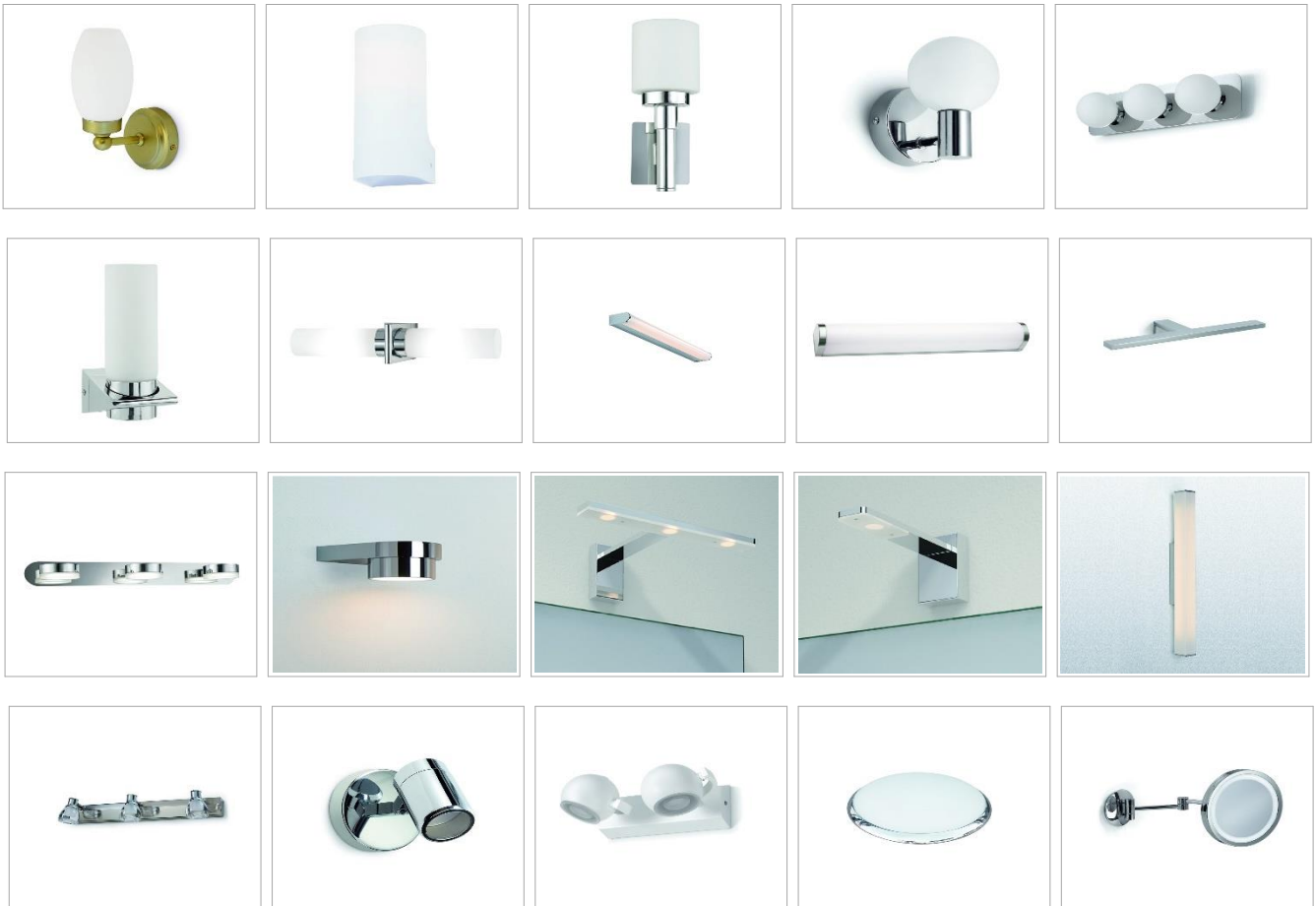

FLOOR LIGHT

LIGHT AS FLEXIBLE AS YOUR PERSONAL DAY.

LIGHT CAN BE ADJUSTED INTUITIVELY TO YOUR INDIVIDUAL NEEDS. WITH THE APP CONTROL SYSTEM, FLOOR BECOMES A FLEXIBLE TOOL. ON THE BASIS OF SIMPLE QUESTIONS ABOUT YOUR DAILY WORKING HABITS, THE APP CALCULATES YOUR PERSONAL LIGHT CURVE, WHICH IS TRANSMITTED TO THE LAMP VIA BLUETOOTH. THE INTENSITY AND COLOR OF THE LIGHT ARE REGULATED AUTOMATICALLY. THERE IS NO EASIER WAY.

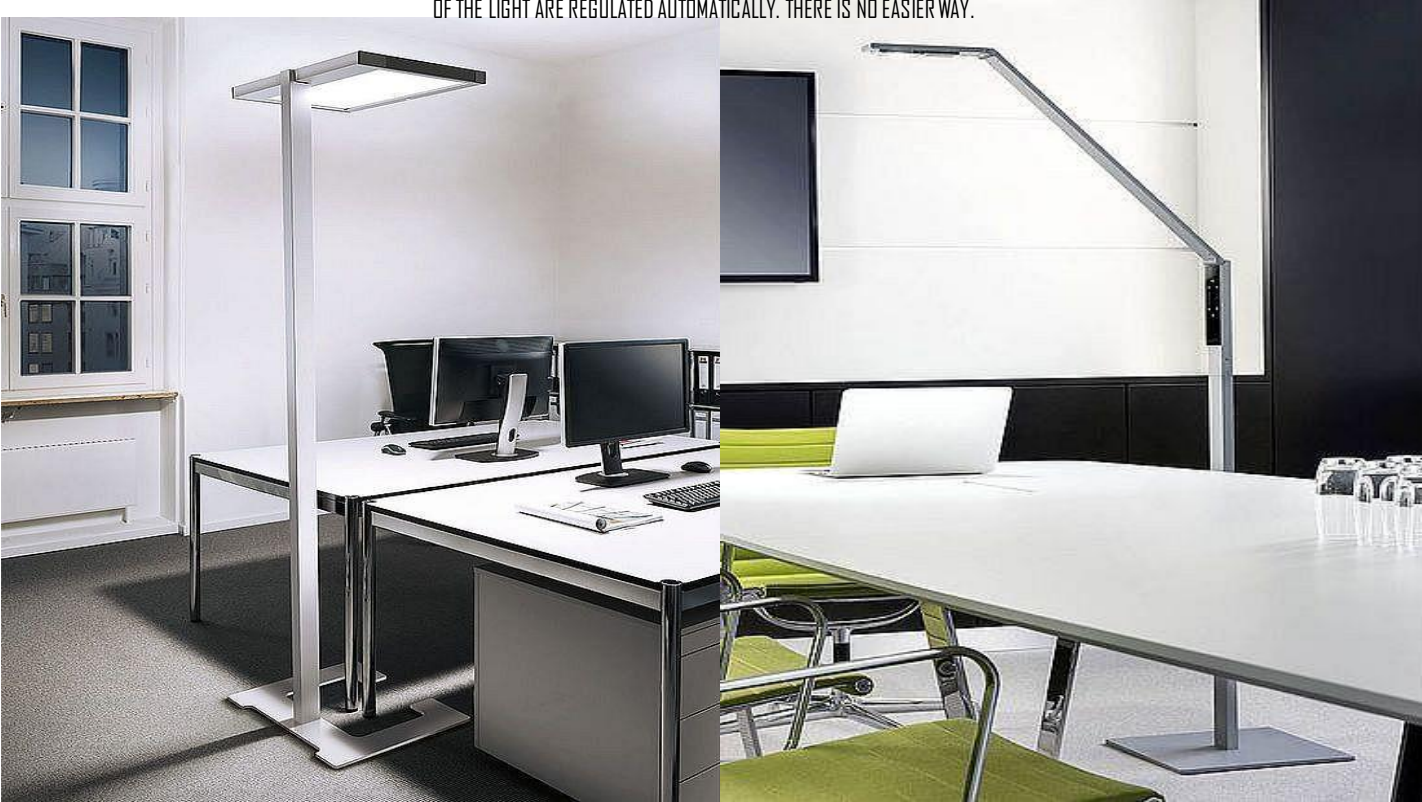

LED PHOTO PANELS

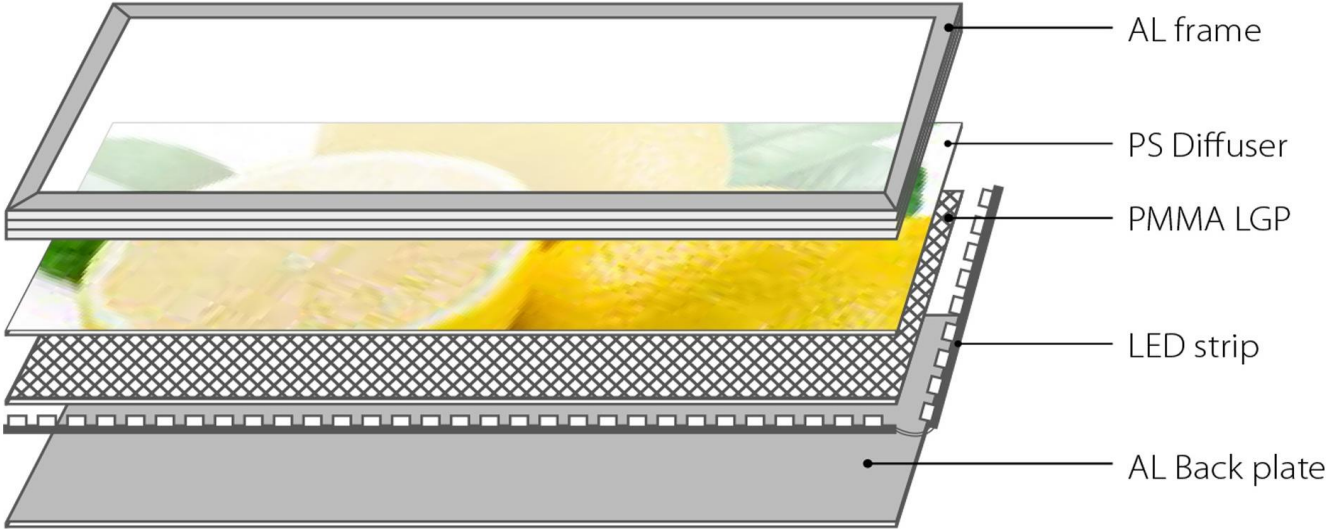

EMERGENCY



INDUSTRY



HAZARDOUS AREA



CRYSTAL CHANDELIERS

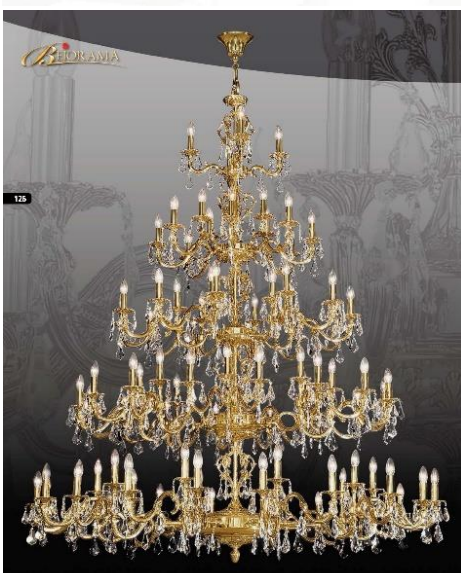

125

11

4

ALORANIA

ALORANIA

Cefia



BRASS CHANDELIERS



MS-0099
size h 350 cm x d 350 cm

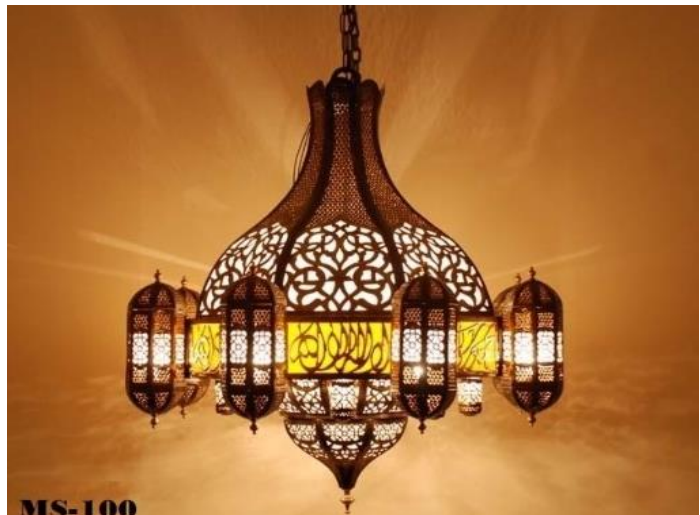

MS-100
size H 100 cm x d 100 cm



MS-098
size H 100 cm x d 60 cm



size H 185 cm x d 165 cm



MS-0048
size H 115 cm x d 95 cm



size H 85 cm x d 50 cm



size H 85 cm x d 35 cm



size H 60 cm x d 30 cm



size H 120 cm x d 75 cm



MS 0067
size H 100 cm x d 90 cm



size H 85 cm x d 70 cm



MS-108
size H 100 cm x d 90 cm



MS-0093
size H 9 cm x d 25 cm



size H 80 cm x d 25 cm



size H 140 cm x d 20 cm



size H 90 cm x d 25 cm



size H 90 cm x d 40 cm

EXTERIOR

- STREET POLES
- DECORATIVE POLES
- URBAN
- FLAG POLE
- BUILDING ELEMENT
- LUMINAIRES
- SKY PROJECTOR
- SMART POLE
- LANDSCAPE
- SOLAR

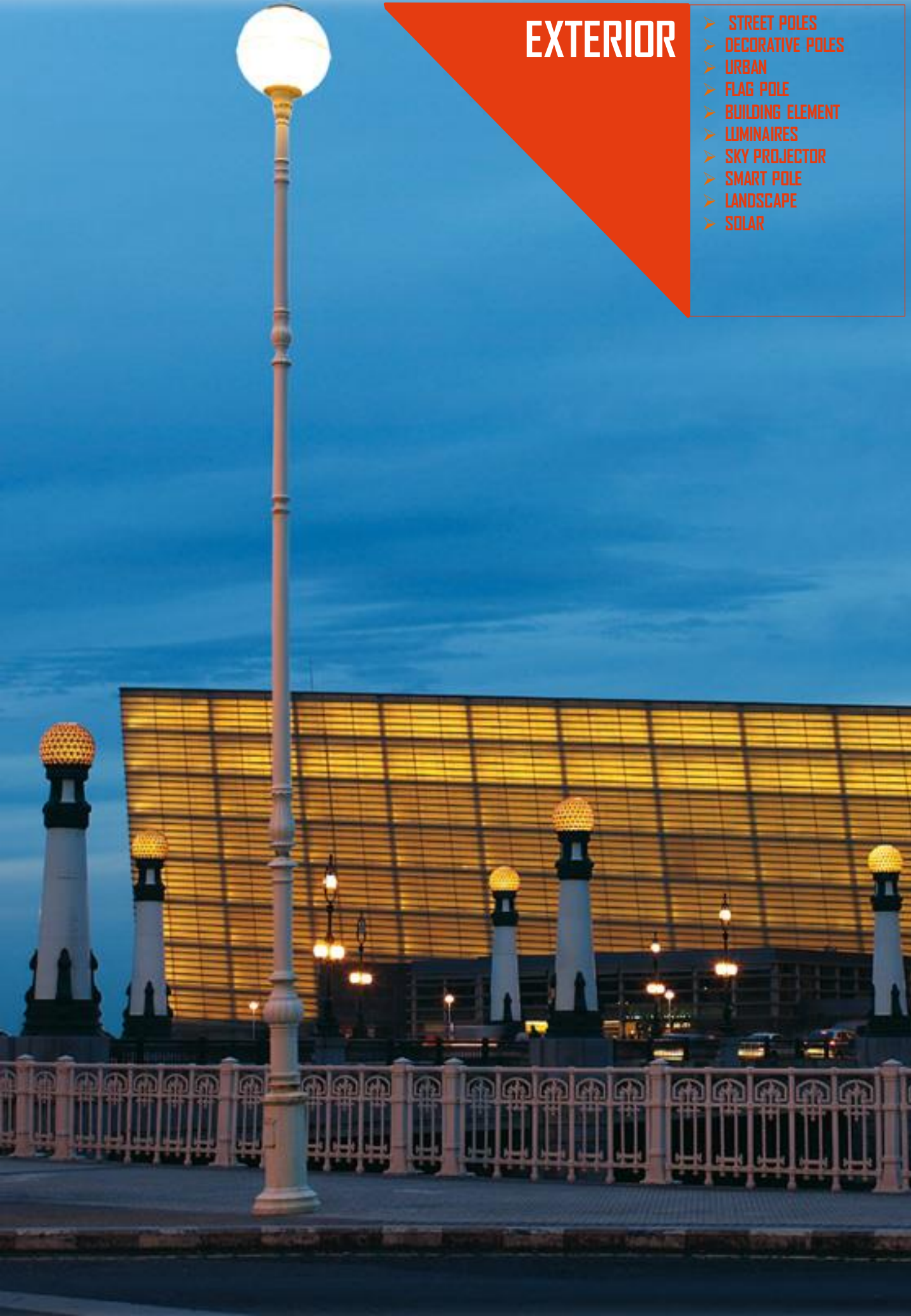

STREETS POLES

- **HIGHMAST POLES** With Raising & lowering Device , Ladder Cage Platform for Stadiums , Parks , Highways...
 - **HDG OCTAGONAL POLE**
 - **HDG CONICAL POLE**
 - **FIBER GLASS POLE**
- With Short,Long,Decorative Arms & Customized Arms Available Upon Request
POWDER COATING FINISH AVAILABLE UPON REQUEST

CURVE SHAPE



WOODEN POLE



DECORATIVE POLES

CLASSIC

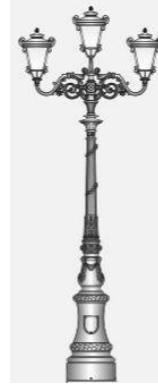
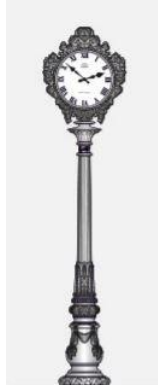

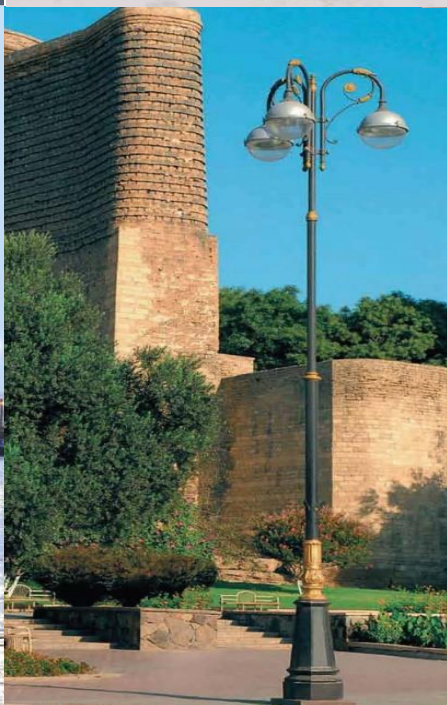

L SHAPE



ISLAMIC DESIGN



URBAN



ECLATEC



Ghm



ECLATEC



FLAG,CAMERA,TRAFFIC POLES



CUSTOM MADE SOLUTIONS



BUILDING ELEMENT

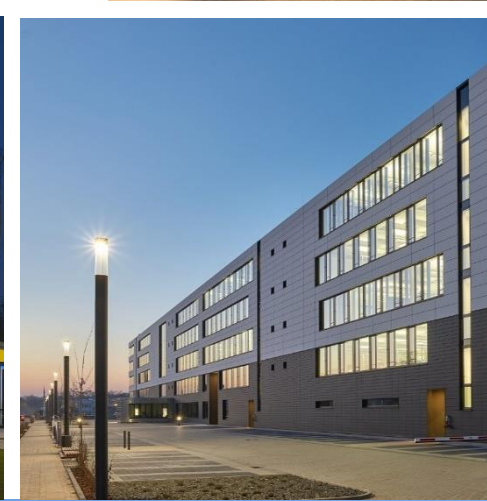
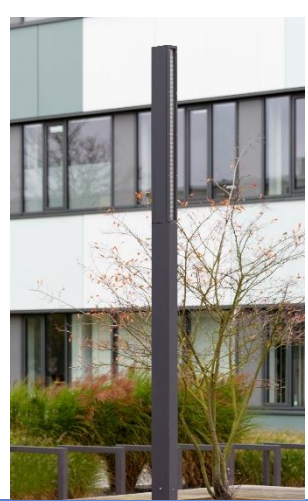
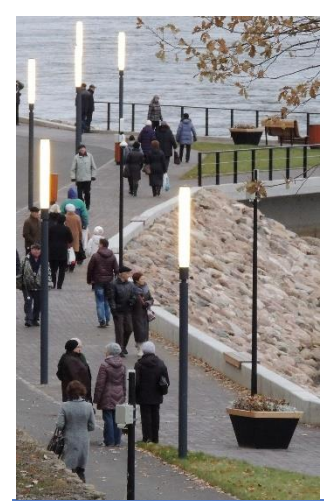
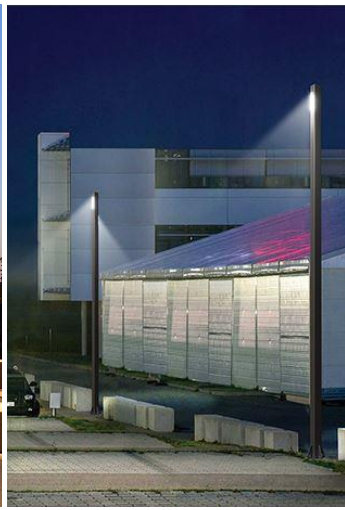

LUMINAIRES

GARDENS, PATHWAYS, PARKS



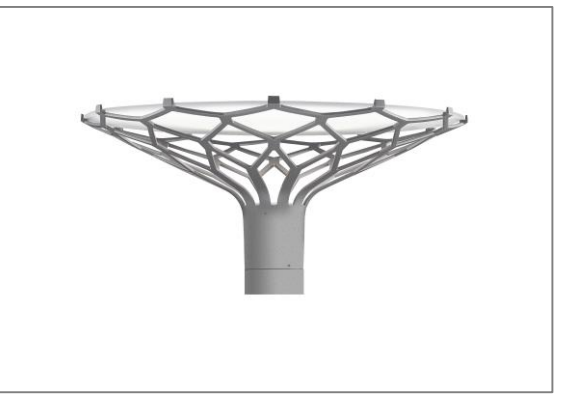
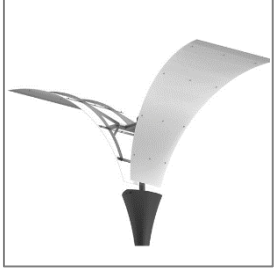

STREET - STADIUM - TUNEL

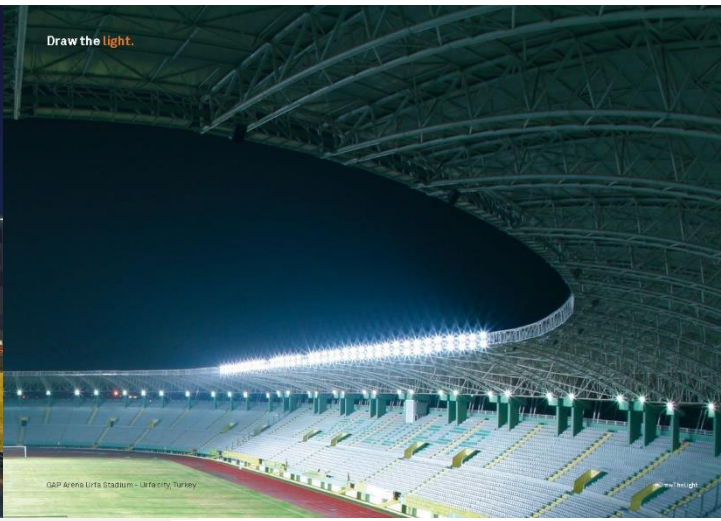
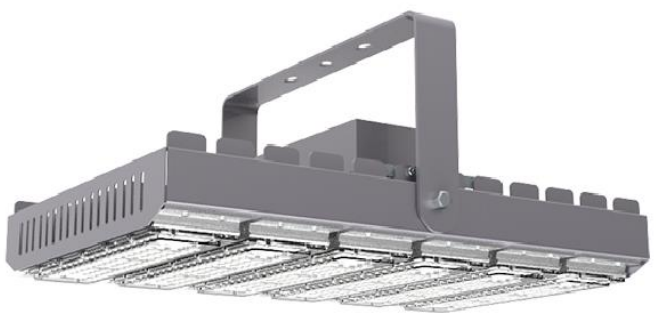

SKY PROJECTOR





WIFI
communication



CAMERA
security
500mm



CLEVER LIGHT
intelligent light management



LED TECHNOLOGY
lighting
FF, 700mm



LED TECHNOLOGY
lighting
FF, 500mm



LOUDSPEAKER
music and announcements



DISPLAY
multimedia



- 210mm x 250mm
- reading height: 1.40m – 1.60m
- HD ready (16:9)
- 1366 x 768 pixel
- 4mm thick clear toughened glass glazing against vandalism
- integrated within the rectangular profile

THE FUTURE IS NOW

The world has changed and there are huge expectations for urban areas. Only the ones who take this challenge as a chance will create an attractive environment with additional benefit for their residents, tourists and business people.

ALL-IN-ONE

What is the challenge? People want to be available everywhere, communicate in a fast way and easily recall all necessary information. At the same time, they want to feel comfortable and save and enjoy a relaxing atmosphere at a unique place. Necessary supply units for e.g. electronic cars or electronic bikes shall be easy accessible and blend in perfectly within the cityscape.

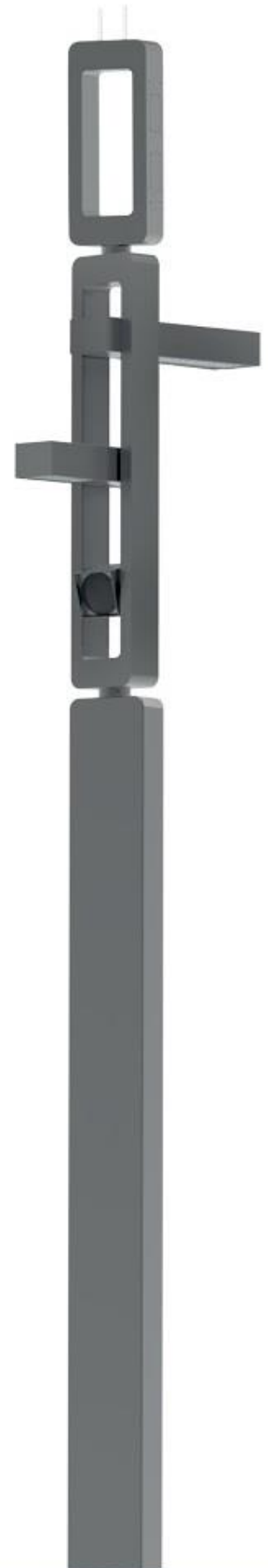

LANDSCAPE

BOLLARDS



BULKHEAD/WALL MOUNTED



STEP LIGHT



FloodLight



SPIKE



UPLIGHT



UNDERWATER



WALL WASHER



LED STRIP

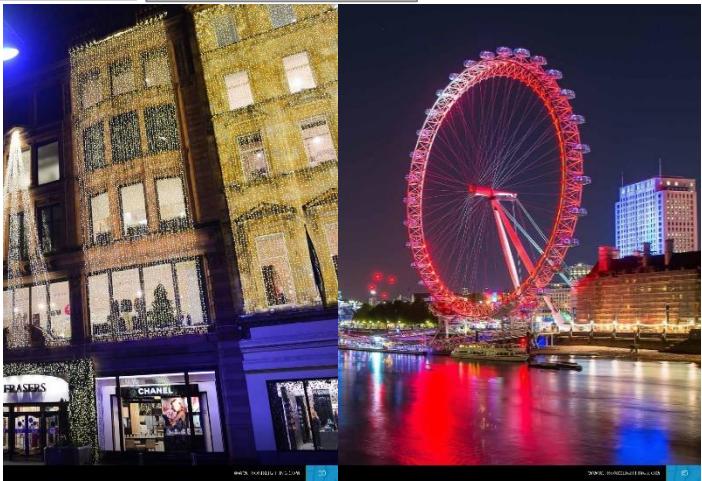



SOLAR LED STREET LIGHT

THE USE OF THE POWER OF THE SUN IS A GREAT CHALLENGE. THE AUTONOMOUS LIGHTS OF THE SS FAMILY PROVIDE YOU WITH THIS FACILITY.

YOU MAY USE SS9A-8C-GV3 FOR LIGHTING DIFFERENT PUBLIC AND PRIVATE SITES, STREETS, PARKS, ALLEYS, QUAYS, AREAS BETWEEN BUILDINGS – FREE OF TAKING CARE ABOUT THEIR MAINTENANCE.

SS9A-8C-GV3 IS AN INNOVATIVE, HIGH-TECH PRODUCT WITH A MODERN DESIGN AND UNIVERSAL APPLICATION FOR LIGHTING DIFFERENT AREAS.



False Colours
illuminances

	16.00 lx
	14.00 lx
	12.00 lx
	10.00 lx
	8.00 lx
	6.00 lx
	4.00 lx
	2.00 lx
	0.00 lx

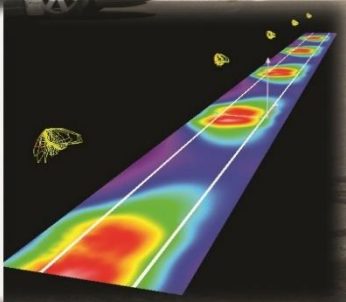

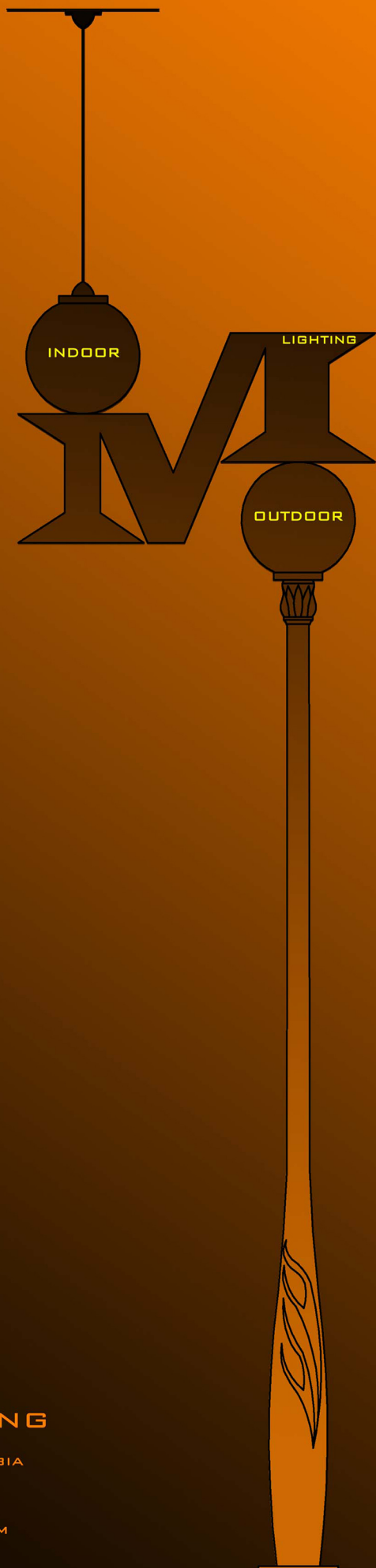

HERAFION LIGHTING

JEDDAH - KINGDOM OF SAUDI ARABIA

TEL: +966 12 261 6641

E-MAIL: HERAFION@MADDLIGHT.COM

WWW.MADDLIGHT.COM